

# 7 Roadside Features

## 7.1 General

The roadside should be made as forgiving as possible, as a matter of good road design practice. An adequate clear zone should be provided to give drivers of errant vehicles an opportunity to recover and stop safely or return to the roadway, and where this is not possible, to reduce the severity of the resulting crash as much as possible. Recommended roadside design procedures to provide an adequate clear zone include:

- Remove obstacles or redesign them so the roadside can be traversed safely.
- Relocate obstacles to a point where they are less likely to be struck.
- Reduce impact severity by using appropriate breakaway designs.
- Redirect vehicles by shielding obstacles with longitudinal traffic barriers and/or crash cushions.
- Delineate obstacles where the above alternatives are not appropriate.

The application of consistent geometric design standards for roads and streets provides motorists with high a degree of safety. Design features such as horizontal and vertical curvature, lane and shoulder widths, signing and road pavement markings each play an important role in keeping a motorist on the road. Roadside safety features, such as breakaway supports, bridge safety barriers and crash cushions provide an extra margin of safety when vehicles inadvertently leave the road. Most of these devices are installed on the basis of a subjective analysis of their safety benefits. Each project is unique and offers an individual opportunity to enhance that particular roadside environment from safety perspective.

The benefits derived from a road safety treatment can be calculated by first estimating the number of vehicles that are likely to run off the road at a particular location. A run off the road incident is defined as an encroachment and the number of encroachments likely to occur at a given location is mainly related to the traffic volume, road alignment and lane width.

All encroachments do not, however, result in crashes because the end result depends upon the physical characteristics of the roadside environment. Flat, traversable slopes will minimise overturning type crashes while the elimination of roadside hazards or their relocation to less vulnerable areas and the use of breakaway type devices will also improve roadside safety. Hazards that cannot be otherwise treated should be shielded by properly designed safety barriers or crash cushions.

When the number of crashes likely at a given location has been estimated it must be translated into crash risk which is directly related to accident severity.

## 7.2 Ditches and Back Slopes

### 7.2.1 General

The majority of rural roads will have ditches in one form or other. Their primary function is to collect and carry away the surface water away from the carriageway. Ditches are designed to accommodate the runoff from heavy rain with minimal flooding or damage to the road. Deep ditches constructed close to the carriageway are the most efficient in removing and retaining the water from the road surface but they are, however, a hazard for errant vehicles. Good ditch design requires a consideration of roadside safety as well as hydraulic efficiency.

Ditches are classified by their slope change, ie. an abrupt or gradual slope change. The abrupt slope change type includes 'V' ditches, rounded ditches with a bottom width < 2.4m and trapezoidal ditches with a bottom width < 1.2m. The gradual slope change type includes rounded ditches with a bottom width ≥ 2.4m and trapezoidal ditches with a bottom width ≥ 1.2m.

An errant vehicle leaving the road and encroaching onto a roadside ditch faces three hazards:

- The Front Slope:** If the front slope of a ditch is 1:4, or steeper, the majority of vehicles will be unable to stop and can be expected to reach the bottom of the ditch.
- The Ditch Bottom:** Abrupt slope changes can result in errant vehicles impacting the ditch bottom.
- The Back Slope:** Vehicles travelling through the ditch bottom, or becoming airborne from the front slope, can impact the back slope.

### 7.2.1 Ditches

Figures 7.1 (a) and 7.1 (b) show design details for abrupt and gradual slope change ditch designs. Ditch cross sections which fall within the shaded regions of these figures are considered traversable, not hazardous and do not need to be constructed at, or beyond, the clear zone distance.

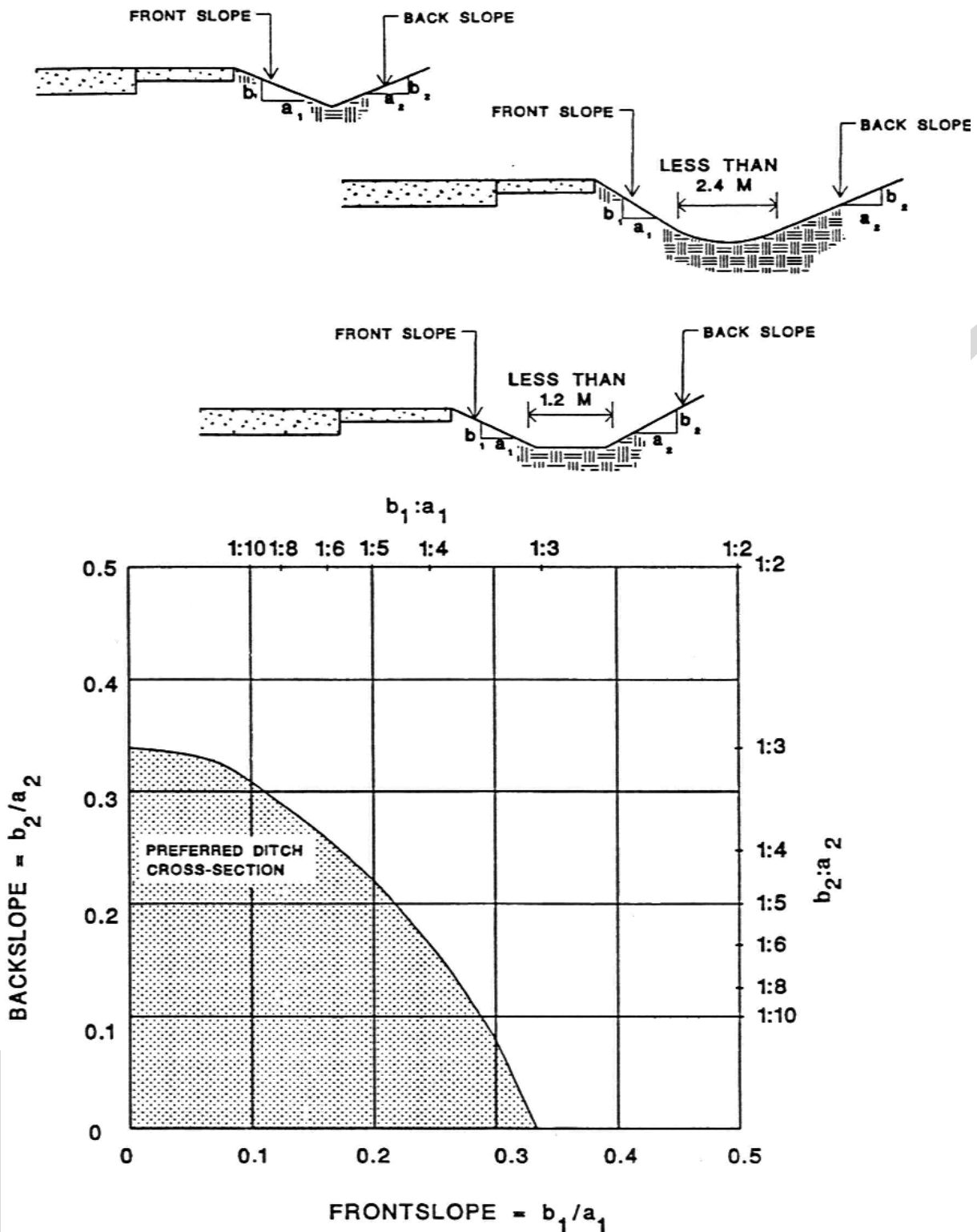

Figure 7.1 (a): Preferred Cross Sections for Ditches with Abrupt Slope Changes

**NOTE:** This diagram is applicable to all 'V' Ditches, Rounded Ditches with bottom widths < 2.4 m, and Trapezoidal Ditches with a bottom widths < 1.2m.

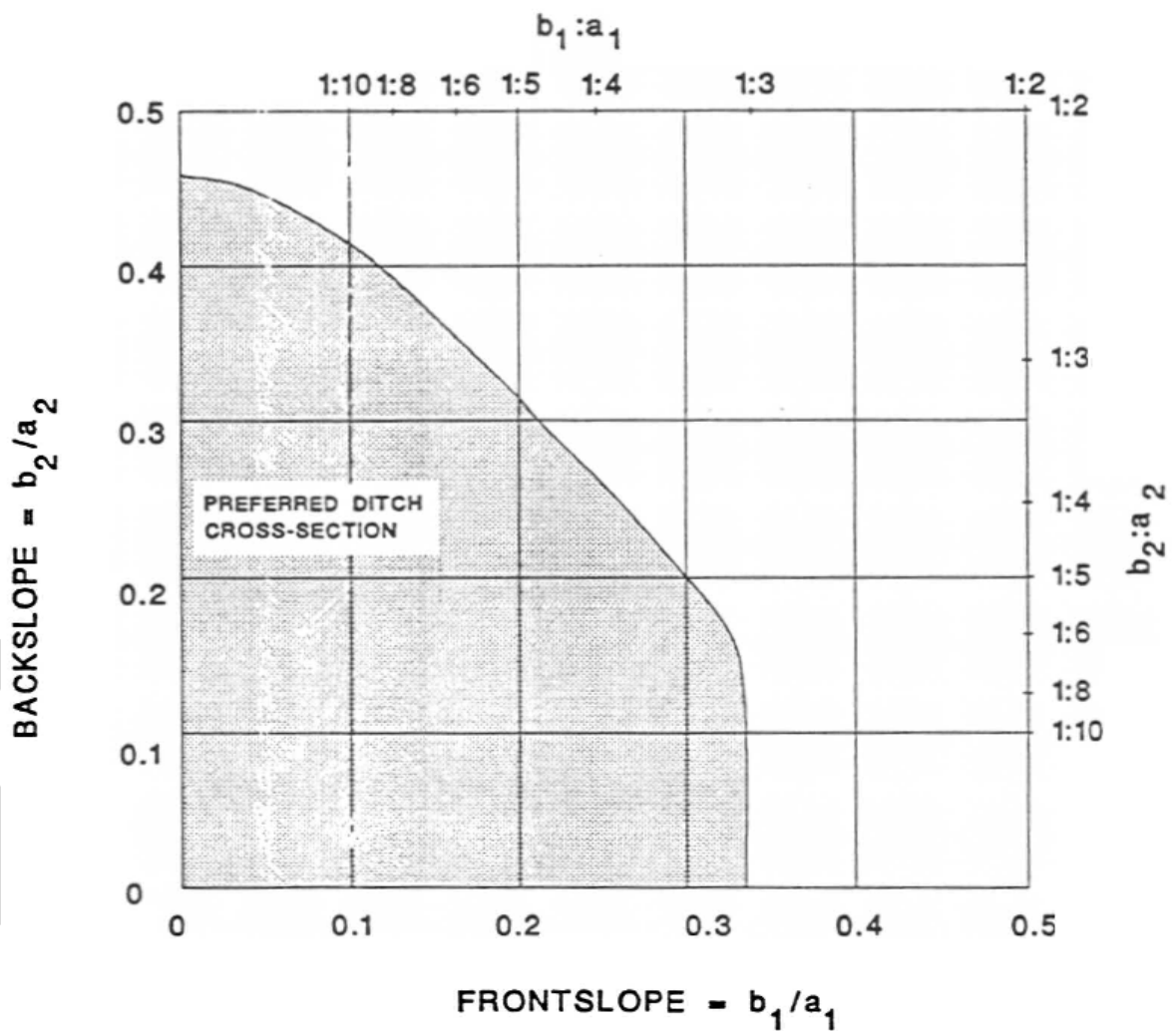
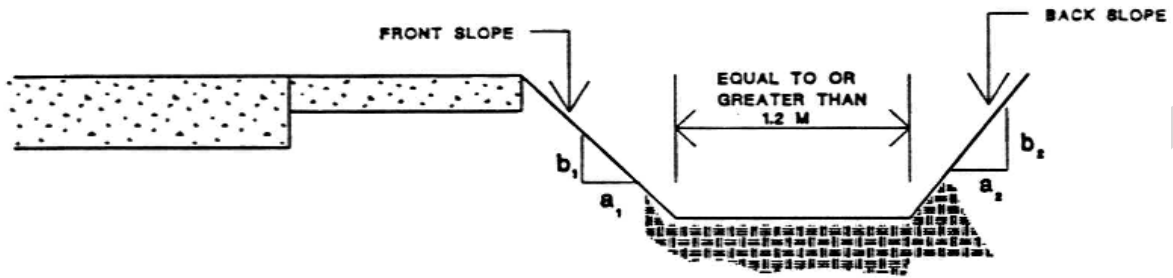
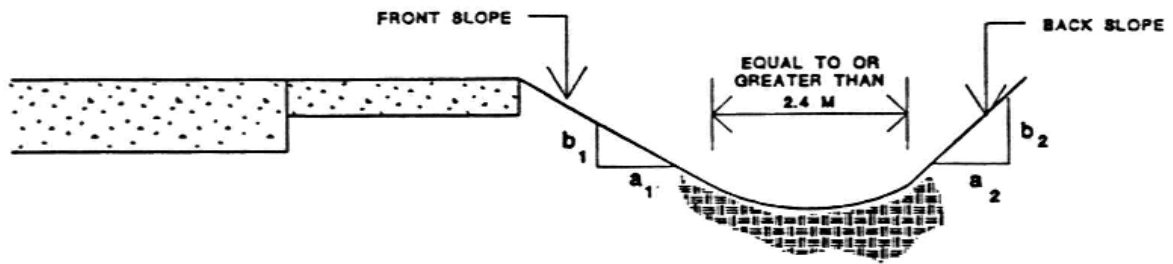

Figure 7.1 (b): Preferred Cross Sections for Ditches with Gradual Slope Changes

**NOTE:** This diagram is applicable to Rounded Ditches with bottom widths of  $\geq 2.2$  m, and Trapezoidal Ditches with bottom widths  $\geq 1.2$  m.

Ditch cross sections that fall outside the shaded areas of figures 7.1 (a) and 7.1 (b) are considered non-traversable. As a general rule these types of ditches should be located beyond the clear zone, reshaped, converted to a closed system (culvert or pipe), or in some cases shielded with a traffic barrier.

If the ditch bottom and side slopes are free of fixed objects a non-preferred ditch cross section may, however, be acceptable:

- where the road reserve width is restricted,
- in rugged terrain,
- on resurfacing, restoration/rehabilitation projects, and
- on low volume, low speed roadways.

Both abrupt and gradual ditch slope change designs can funnel a vehicle along the bottom of the ditch. This increases the probability of an impact with a fixed object located on the side slopes or ditch bottom. Breakaway hardware may also not operate correctly if the vehicle is airborne or sliding sideways when contact is made. For these reasons, non-yielding fixed objects should not be located on the side slopes or bottoms of ditches.

### 7.2.2 Back Slopes

Back slopes are formed when a road formation is constructed by cutting into the existing terrain. These slopes are more commonly known as 'cut slopes'.

If the ground slope between the carriageway and the base of an obstacle free back slope is 1:3 or flatter the back slope may not present a significant hazard, regardless of its distance from the roadway.

Back slopes that do not provide a relatively smooth vehicle redirection or could cause vehicle snagging, eg. a rough rock cut, should be located outside the clear zone or be shielded.

### 7.2.3 Clear Zone Determination for Ditches and Back Slopes

#### (a) Ditch Analysis for AADT 1200 vpd and a Design Speed of 90km/h

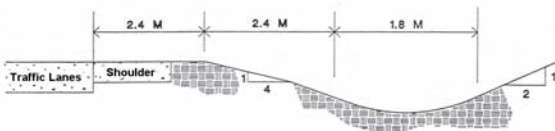

The distance from the edge of the traffic lane to the start of the ditch is 4.8 m. From Table 6.10 the clear zone required for a 1:4 fill slope on a straight level section of road is 6.0 to 7.5 m. This is 1.2 to 2.7 m less than what is available.

Figure 7.1(a) indicates that a 1.8 m wide rounded ditch bottom with a 1:4 front slope and a 1:2 backslope is not a preferred design. It should not, therefore, be located within the clear zone.

If the probability of vehicle encroachment is small, and the ditch bottom and back slope are free of obstacles, no additional improvement may be necessary.

If, however, the ditch is located on the outside of a horizontal curve where the probability of encroachment is high and the angle of impact is straighter, some flattening of the backslope and/or widening of the ditch should be considered as safety improvements.

#### (b) Back Slope Analysis for AADT 1300 vpd and a Design Speed of 70 km/h

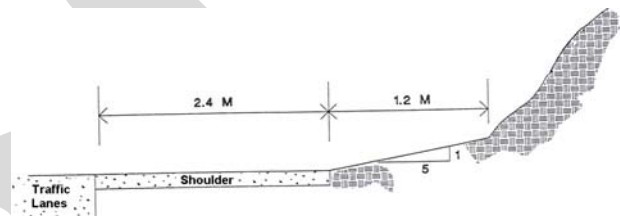

From Table 6.10 the clear zone required for a 1:5 cut slope on a flat, straight section of road is 3.5 to 4.5 m.

The distance available between the edge of the traffic lanes and the start of the cut slope face is 3.6 m, which is 0.1 m more to 0.9 m less than the clear zone required.

If the section of road has a history of accidents related to vehicles hitting the back slope face, or the face of the slope is rough and has the potential to cause snagging or overturning of an impacting vehicle, then shielding it with a longitudinal barrier should be considered as a safety improvement.

## 7.3 LONGITUDINAL ROAD SAFETY BARRIERS

### 7.3.1 NCHRP Report 350

This report is based on extensive practical experience with longitudinal roadside safety barrier performance in the United States, and also engineering judgement. The National Cooperative Highway Research Program Report 350 (NCHRP 350) established three criteria to evaluate the safety performance of roadside hardware, ie. structural adequacy, occupant risk and post impact vehicle response. These criteria are summarised below:

#### (a) Structural Adequacy

The test hardware must contain and redirect the vehicle. The vehicle should not penetrate, under-ride or over-ride the installation although controlled lateral deflection of the test article is acceptable.

#### (b) Occupant Risk

Detached elements, fragments, or other debris from the test article should not penetrate the occupant compartment or present an undue hazard to other traffic.

#### (c) Post Impact Vehicle Response

After a collision, it is preferable that the vehicle's trajectory does not intrude into adjacent traffic lanes.

Evaluation of the safety performance of roadside hardware is based on actual crash testing. NCHRP 350 describes the vehicles to be used for the tests, the test conditions and the instrumentation that must be used. The test criteria are hardware specific, ie. longitudinal barriers, barrier terminals, crash cushions and support structures. The test matrix for longitudinal barriers is shown in Figure 7.2.

### 7.3.2 AS/NZS 3845:1999 - Road Safety Barrier Systems

The joint Australian and New Zealand Standard, AS/NZS 3845:1999 - Road Safety Barrier Systems, was published on 5 January 1999. It is based on NCHRP 350 and provides specific requirements for the installation and maintenance of road safety barriers.

Various vehicle impact parameters are identified in AS/NZS 3845 and grouped into the test levels described in NCHRP 350. The standard does not, however, provide guidance on the applicability of these test levels to actual site, road and traffic conditions but recommends that a risk management approach should be used to determine the appropriate test level for a barrier at a particular site

Some non-patented public domain devices that are deemed to comply with NCHRP 350 Test Level 3 (NCHRP 350 TL - 3) are described in AS/NZS 3845

### 7.3.3 TNZ M/23 : 2002 - Specification for Road Safety Barrier Systems

TNZ M/23 : 2002 is Transit's specification for the supply and installation of safety barrier systems for state highways. All

state highway roadside safety barrier systems must comply with this specification. The minimum performance level for state highway safety barriers is TL - 3 and evidence of compliance with this, or a higher specified NCHRP 350 test level, must be provided when requested.

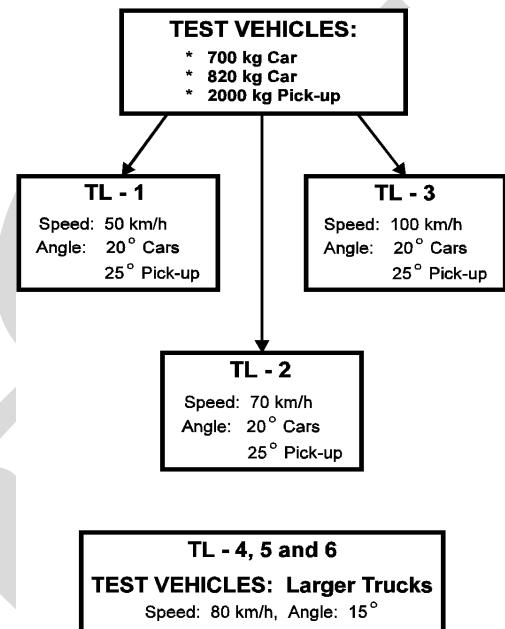

Figure 7.2: NCHRP 350 Test Matrix for Longitudinal Barriers

### 7.3.4 Road Safety Barrier Performance and Risk Management

#### (a) General

Risk management is an integral part in the selection of an appropriate roadside safety barrier system and Transit is currently developing a guide for the risk management process. **Until this guide is published the minimum standard for all roadside safety barriers erected on a state highway shall be NCHRP 350 TL-3.**

#### (b) Median Barriers

Most median safety barriers have been developed and tested with the intention of containing and redirecting passenger vehicles. Where there is a high percentage or large average daily number of heavy vehicles, adverse geometrics (horizontal curvature and gradient), or severe consequences of vehicular (or cargo) penetration into the opposing traffic lanes, higher performance barriers having significantly greater capabilities should be used. The method for determining state highway median barrier performance levels is described in Section 7.3.12 *Median Barriers*.

#### (c) Special Conditions

**Designer's must apply engineering judgement to the nature of all roadside hazards that require shielding by safety barriers and specify higher performance barrier's whenever they are considered necessary.**

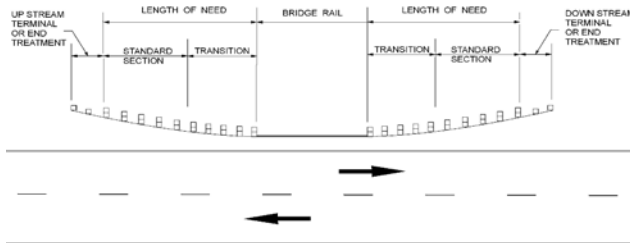

Figure 7.4: Longitudinal Roadside Safety Barrier System Elements

### 7.3.5 Longitudinal Roadside Safety Barrier System Elements

The various elements that make up a typical longitudinal roadside safety barrier system are illustrated in Figure 7.4. Median barrier systems are virtually identical but the elements are designed to resist impacts from either side. The functions of the various barrier elements are:

#### (a) Terminal, or End Treatment

The purpose designed modification to the end of a standard design longitudinal road safety barrier which is intended to safely accommodate end impacts and allow development of the structural capacity of the barrier.

#### (b) Length of Need (LON)

The total length of standard design barrier needed to shield the area of concern.

#### (c) Standard Section

The length of standard design barrier.

#### (d) Transition

The length of barrier between two different barrier types, or between a barrier and a bridge rail or a rigid object such as a bridge pier, which is designed to provide a gradual change in stiffness that will prevent vehicle pocketing or snagging.

### 7.3.6 Road Safety Barrier Location and Layout

The factors that must be considered in the location and layout of road safety barriers are:

- offset from the edge of traffic lane,
- deflection requirements,
- any terrain effects,
- flare rate, and
- length of need.

These factors are discussed and described in more detail in

Sections 7.3.7 to 7.3.13.

### 7.3.7 Offset from Edge of Traffic Lane (Shy Line)

In most cases a longitudinal roadside safety barrier should be placed as far from the edge of the traffic lane as conditions permit. The advantages of a greater lateral offset include:

- more space to regain vehicle control,
- better sight distance,
- less barrier required to shield a hazard, and
- reduced driver reaction to the barrier.

Drivers tend to react adversely to objects placed too close to the edge of a traffic lane by slowing unnecessarily or steering away. The distance from the adjacent traffic lane beyond which a roadside features do not cause such a reaction is termed the 'shy line offset'.

It is desirable to place all roadside features beyond the shy line and, to the extent possible, maintain a constant offset. However, in the case of long continuous runs of longitudinal barrier the offset distance is not quite so critical, particularly if the barrier is started beyond the shy line and is gradually tapered closer to the roadway. It is important that any changes of barrier offset are accomplished gradually, to avoid startling drivers and to prevent vehicle pocketing in the event of impacts in the offset transition area.

The shy line offsets shown in Table 7.1 below should be provided wherever possible.

Design or 85 <sup>th</sup> Percentile Speed (km/h)	Shy Line Offset - $L_s$ (m)	
	Nearside (Left)	Offside (Right)
≤ 70	1.5	1.0
80	2.0	1.0
90	2.5	1.5
≥ 100	3.0	2.0

Table 7.1: Shy Line Offsets

Roadside safety barriers should not be located at the edge of the shoulder unless a narrow clear zone or median is involved, because this removes usable recovery area from possible use and increases the probability of barrier collisions.

When the hazard to be shielded is located near the outer limit of the clear zone, the barrier location is usually dictated by roadside geometry. Moving the barrier closer to the hazard and away from the carriageway can, however, have a negative effect because the further a barrier is from the carriageway the greater the impact angle is likely to be. A larger impact angle may result in increased collision severity and the risk of a vehicle penetrating the barrier.

Increasing the barrier offset also means that the intervening roadside area must not only be traversable, but that its slope must be kept as flat as possible. Vehicle interaction with a barrier is highly dependent on the vehicle's attitude at impact.

Side slopes that are perfectly acceptable in terms of vehicles traversing the slope safely may produce adverse impact reactions when a barrier is located on the slope.

### 7.3.8 Deflection Distance

The expected deflection of a roadside safety barrier must not exceed the space available for it to freely deflect. Rigid, semi-rigid, and flexible barrier systems vary greatly in their expected deflection upon impact by a vehicle. Figures 7.4 (a) and (b) illustrate two situations where the barrier deflection distance is important and must be considered.

Figure 7.4 (a) shows a roadside safety barrier shielding a rigid object. The barrier-to-object distance must be sufficient to prevent an impacting vehicle from deflecting the barrier sufficiently to hit the object. If the obstacle is immediately adjacent to the barrier, a rigid barrier is the only choice. If the space available between the object and barrier is not adequate for a semi-rigid system the barrier can often be stiffened in advance of, and alongside, the object. Commonly used methods to reduce deflection in a semi-rigid or flexible barrier include reducing the post spacing, increasing the post size, the use of soil plates, intermediate anchorages, and stiffened sections.

Very stiff or rigid barriers may cause vehicles to roll or tip over on impact. This concern is greatest for large trucks and other high-centre-of-gravity vehicles, which may also climb up the barrier face. All these factors must be considered when determining the position and height of barriers, especially where truck traffic is a concern.

Figure 7.4 (b) shows a roadside safety barrier on a fill embankment. The main concern in these situations is to prevent vehicles rolling as the barrier deflects. This requires the fill embankment material to be able to provide a sufficient resistance to post movement. Full-scale tests and experience has shown that a semi-rigid barrier placed a minimum of 600 mm from the edge of a fill embankment is generally adequate but wherever possible 1.0 m should be provided.

Even flexible systems, eg. cable barriers, may provide an acceptable performance when installed with a minimum of 600 mm from the back of the post to the top of a slope provided the slope is no steeper than 1:2. This distance is, however, an absolute minimum and is very dependent on the slope of the fill embankment, soil type, expected impact conditions, post cross section, post size, etc and needs to be increased in most cases.

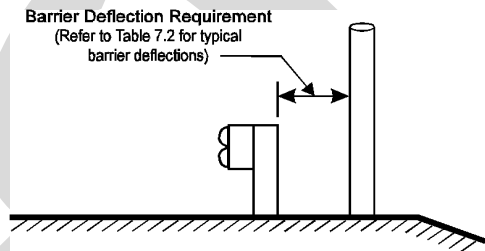

Figure 7.4 (a): Deflection Requirement for Flexible and Semi-rigid Barriers

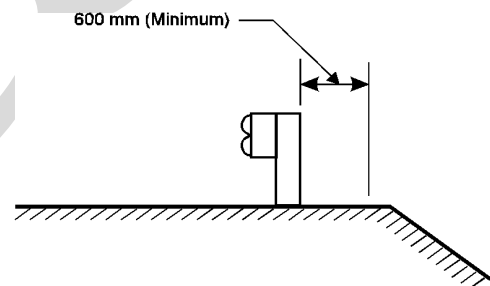

Figure 7.4 (b): Barrier Placement on Fill Embankments

Deflection characteristics for some of the roadside safety barriers in common use are shown in Table 7.2.

**NOTE:** Analysis of accidents where a heavy have impacted with wire rope barriers in Australia suggests that a minimum design deflection of 3.0 m should be allowed when a flexible cable barrier is to be used where the AADT contains more than 5% heavy vehicles. This is particularly relevant when a wire rope barriers is to be used on a median.

Characteristics	Type	Application	Post spacing	Deflection	Mounting height
 <p>Wire Rope roadside/median barriers</p>	Flexible	TL - 3 Longitudinal roadside/median barrier	Varies with type of barrier (typically 2.4 to 5.0 m)	Varies with type of barrier (typically 1.7 to 3.4 m for a 2000 kg vehicle @ 100 km/h and 25° approach angle - but check with manufacturer)	Varies with type of barrier (top is typically set 675 to 770 mm above ground level)
 <p>W-beam roadside barrier</p>	Semi-rigid	TL - 3 Longitudinal roadside barrier	1905 mm	Approximately 1.0 m (2000 kg vehicle @ 100 km/h and 25° approach angle - but check with manufacturer)	710 mm to top of rail
 <p>Thrie-beam roadside barrier</p>	Semi-rigid	TL - 3 Longitudinal roadside barrier	1905 mm	Approximately 600 mm (2000 kg vehicle @ 100 km/h and 25° approach angle - but check with manufacturer)	805 mm to top of rail
 <p>Modified Thrie-beam roadside barrier</p>	Semi-rigid	TL - 4 Longitudinal roadside barrier	1905 mm	Approximately 900 mm (9000 kg vehicle, 90 km/h, 15° approach angle - but check with manufacturer)	865 mm to top of rail
 <p>W-beam median barrier</p>	Semi-rigid	TL - 3 Longitudinal median barrier	1905 mm	Approximately 600 mm (2000 kg vehicle, 100 km/h, 25° approach angle - but check with manufacturer)	710 mm to top of rail
 <p>Modified Thrie-beam median barrier</p>	Semi-rigid	TL - 4 Longitudinal median barrier	1905 mm	Approximately 500 mm (2000 kg vehicle @ 100 km/h and 25° approach angle - but check with manufacturer) <i>NOTE: Testing has shown that a modified thrie-beam barrier can safely redirect an 18,000 kg vehicle @ 80 km/h and 15° approach.</i>	865 mm to top of rail
 <p>F shape concrete roadside barrier</p>	Rigid	TL - 4/5 Longitudinal roadside barrier	N / A	Negligible if appropriately embedded into the ground.	820 and 1100 mm. If height is reduced to less than 725 mm by pavement overlays vehicles may roll over the barrier.
 <p>F shape concrete median barrier</p>	Rigid	TL - 4/5 Longitudinal median barrier	N / A	Negligible if appropriately embedded into the ground.	820 and 1100 mm. Barrier heights less than 725 mm are undesirable - see note above.

Table 7.2: Typical Design Deflections for Longitudinal Barriers



### 7.3.9 Terrain Effects

#### (a) General

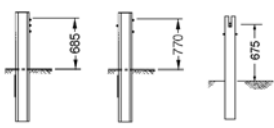
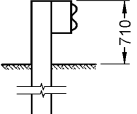
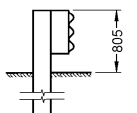
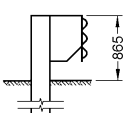
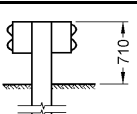
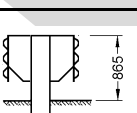
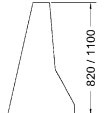
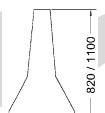
Longitudinal roadside safety barriers perform best when impacted by a vehicle with all of its wheels on the ground, and the suspension components are in their normal position. This requires that the lateral distance from the edge of pavement to the barrier be maintained in as uniform and level condition as possible. Features, such as kerbs and drainage inlets, that may cause vehicle bumpers to be higher or lower than normal, can result in snagging or vaulting.

Changes in side slope in the vicinity of road safety barriers and terminals, sign supports and light/power poles must be graded in a manner that ensures impacting vehicles will not snag any break-away hardware associated with these devices. Figure 7.5 shows the clearance envelope required in these situations, ie. 100 mm over a 1.5 m span.

#### (b) Kerbs

Locating barriers behind kerbs of any type, unless the system is specifically designed and tested in that configuration, eg. a kerbed bridge guardrail, should generally be avoided because errant vehicles can vault over, or break, through the barrier.

However, if a barrier has to be positioned immediately behind a kerb is generally not considered to be a concern in respect to vaulting if:

- the kerb is not more than 100 mm in height, and
- the barrier offset is 230 mm, or less from the kerb face.

Precautions must be taken to ensure vehicle bumpers do not under-ride a barrier rail if the full rail height is provided above the kerb. This may be accomplished by using a deeper rail section or by setting the rail height relative to the pavement surface in front of the kerb.

Regulations require that the body of a motor vehicle must overhang its wheels. To minimise damage to both vehicles and barriers, it is desirable to place barriers 200 to 300 mm behind kerbs in urban areas where speeds are 70km/h or less.

#### (c) Side Slopes

Roadside safety barriers perform most effectively when installed on slopes of  $\leq 1:10$ . Slope changes can result in a vehicle impacting a barrier higher than normal, which is likely to result in the vehicle vaulting the barrier. Therefore, road safety barriers should desirably be placed on embankments slopes  $\leq 1:20$  and normally on slopes no steeper than 1:10.

Strong post W-beam and thrie-beam installations have, however, been tested on 1:6 slopes and found to be marginally satisfactory, due to the tendency of the rail element to bend backward and ramp the vehicle. Based on these results existing installations of W-beam and thrie-beam barrier may be retained on slopes up to 1:6, if they are within the location guidelines shown on Figure 7.6. The offset distance of 3.6 m for slopes between 1:10 and 1:6 allows the vehicle trajectory to stabilise and for it to be in a normal attitude when it impacts the barrier.

#### (d) Shoulders

To help ensure vehicle stability the shoulder should be extended to the face of a roadside safety barrier

When a barrier is located  $\leq 600$  mm from the edge of a traffic lane the full width of shoulder surface should be sealed or paved. This will reduce maintenance since all the vegetation can be removed from behind the barrier.

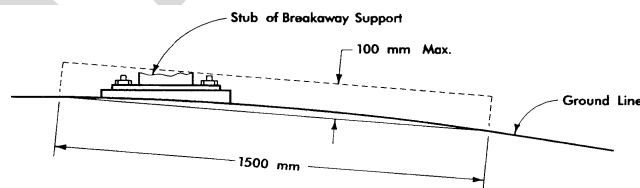

Figure 7.5: Breakaway Hardware Clearance Envelope

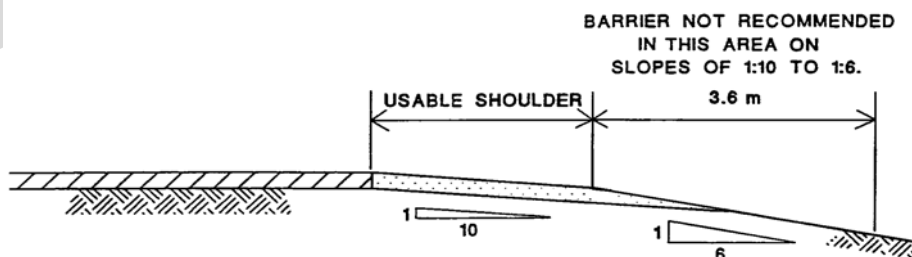

Figure 7.6: Road Safety Barrier Location on Slopes between 1:10 and 1:6

7.3.10 Flare Rates

A flare is normally used to adjust the distance of a roadside safety barrier from the edge of the carriageway. The flare will usually place the barrier terminal or, end treatment, further from the edge of pavement than the barrier itself, can be used to adjust the barrier placement to existing roadside features, may reduce the total length of barrier required and will minimise driver reaction to an obstacle close to the road.

Flared barriers can increase the impact angle and thus the impact severity. They can also result in higher rebound angles, which can cause greater conflicts with other traffic or roadside features. Flare rates should, therefore, be as flat as possible, especially when the flare is within the shy line offset.

The recommended flare rates are a function of design speed and barrier type, ie. the higher the speed and the more rigid the barrier, the flatter the flare rate. Flare rates flatter than those given Table 7.3 may be used particularly where extensive grading would be required to provide the 1:10 maximum slope approach to the barrier from the travelled way.

Design/Operating Speed (kmh)	Flare Rate		
	Inside Shy Line	Beyond Shy Line	
		Rigid	Non-rigid
≤ 60	1:18	1:12	1:10
70	1:21	1:14	1:11
80	1:24	1:16	1:12
90	1:26	1:18	1:14
≥ 100	1:30	1:20	1:15

Table 7.3: Recommended Flare Rates

7.3.11 Length of Need (LON)

(a) General

Typically, errant vehicles leave the roadway at a relatively flat angle, ie. usually less than 25°, and they may travel a considerable distance along the roadside before colliding with a hazard or fixed object. Roadside safety barriers introduced immediately before, or just upstream of a roadside hazard may not be effective in preventing errant vehicles from travelling behind the barrier and subsequently hitting the hazard.

The total length of standard barrier required to fully shield a hazard is known as the 'length of need'. Both directions of traffic must be considered on two-lane two-way roads, and also on dual carriageway roads with narrow medians. The length of barrier required to fully shield a hazard is illustrated in Figure 7.7 and is:

$$L_{TOTAL} = L_{ADVANCE} + L_{HAZARD} + L_{OPPOSING}$$

Where:

- $L_{ADVANCE}$  = Length needed in advance of the hazard
- $L_{HAZARD}$  = Length of the hazard
- $L_{OPPOSING}$  = Length needed to protect traffic from the opposing direction.

Factors affecting  $L_{TOTAL}$  include:

- the lateral extent of the hazard to be protected,
- the stopping distance required for a vehicle to avoid striking the hazard, and
- the geometric layout of the barrier including the lateral offset, flare rate, and location of the flare.

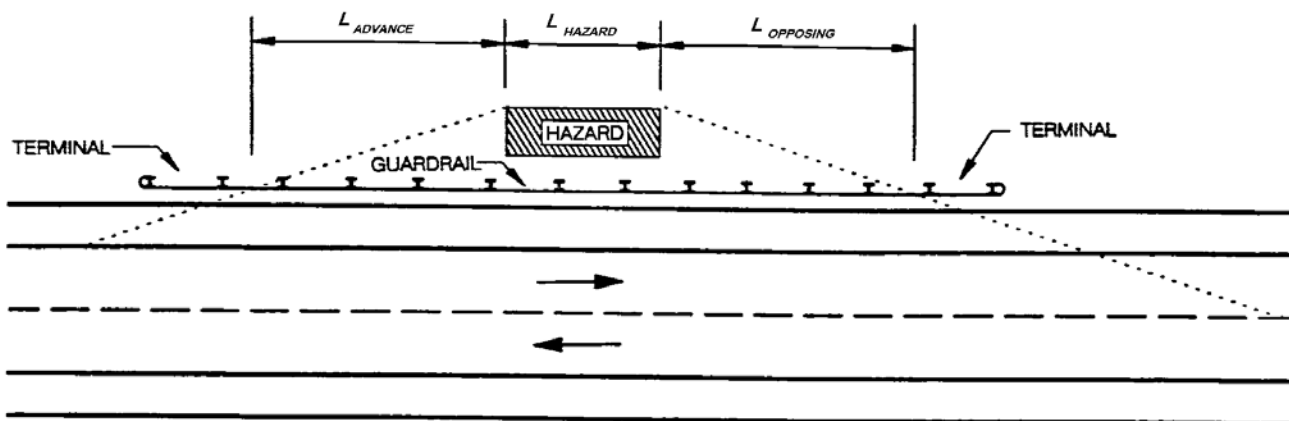

Figure 7.7: Length of Barrier Needed to Shield a Hazard on a Two-way Two-lane Road

**(b) Runout Length**

The design of roadside safety longitudinal barriers must ensure that a sufficient length of barrier is placed in advance of the hazard to prevent errant vehicles leaving the roadway from travelling behind the rail and hitting the hazard before their drivers are able to bring them to a stop.

The theoretical distance for vehicles to stop in these situations is termed the 'Runout Length' and it is dependent upon vehicle speed and the friction available between the vehicle tyres and the usually unpaved roadside surface.

The runout lengths,  $L_R$ , shown in Table 7.4 are from the AASHTO Roadside Design Guide - Table 2.6.6. These are based on actual field studies.

Design Speed (km/h)	Traffic Volume (AADT)			
	Under 800	800 - 2000	2000 - 6000	Over 6000
	Runout Length - $L_R$ (m)			
50	40	45	50	50
60	50	55	60	70
70	60	65	75	80
80	75	80	90	100
90	85	95	105	110
100	100	105	120	130
110	110	120	135	145

**Table 7.4: Recommended Runout Lengths**

**(c) Length of Barrier Needed in Advance of a Hazard for Adjacent Traffic -  $L_{ADVANCE}$**

Figure 7.8 shows the design and layout details required to calculate the length of roadside safety barrier needed in advance of a hazard, for adjacent traffic on a straight, or nearly straight, section of road.

The runout length,  $L_R$ , is measured back from the face of the hazard along the edge line of the traffic lane.

A diagonal line, known as the 'control line', is constructed from the end of the runout length to the point on the hazard furthest from the edge line, ie. the distance  $L_A$ . The length of standard barrier required is measured from the face of the hazard to the point where the barrier line intersects the control line. A terminal conforming to at least NCHRP 350 TL - 3 must be provided in advance of the standard barrier section.

Where a barrier is designed to shield a continuous hazard, such as a river or a critical embankment, the offset  $L_A$  should be the clear zone distance,  $L_C$ .

The equation to calculate the length of barrier needed, is:

$$X = \frac{L_A + [(b/a) \times L_1] - L_2}{(b/a) + (L_A / L_R)}$$

If a flare is not used  $L_1 =$  zero (0) and the equation reduces to:

$$X = \frac{L_A - L_2}{(L_A / L_R)}$$

The equation to calculate the barrier flare offset is:

$$Y = L_A - \left[ \left( \frac{L_A}{L_R} \right) \times X \right]$$

- $L_1$  = Length of tangent section of barrier, measured from the hazard to the start of the flare.
- $L_2$  = Distance from edge of the traffic lane to the tangent section of barrier.
- $L_3$  = Distance from edge of the traffic lane to the hazard.
- $L_A$  = Distance from edge of traffic lane to the back of the hazard, usually the smaller of  $L_3$  or  $L_C$ .
- $L_C$  = Clear zone width from Table 6.10 or Figure 6.12
- $L_S$  = Shy line offset - from Table 7.1
- $b/a$  = Flare rate - from Table 7.3
- $L_R$  = Runout length - from Table 7.4
- $X$  = Length of standard barrier needed
- $Y$  = Lateral offset from edge of traffic lane.

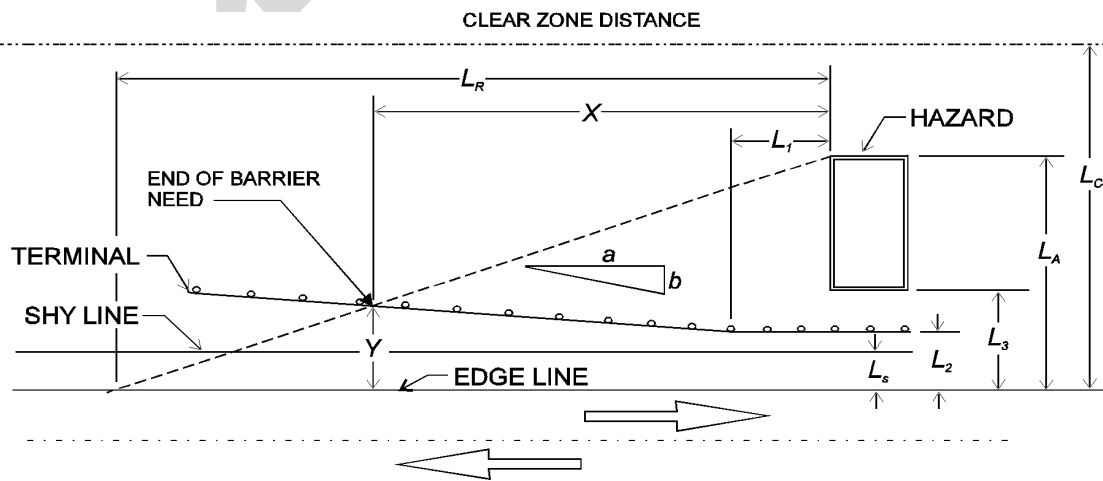

**Figure 7.8: Length of Barrier Needed in Advance of a Hazard for Adjacent Traffic**

(d) Length of Barrier Needed in Advance of a Hazard for Opposing Traffic -  $L_{OPPOSING}$

A process similar to the calculation of  $L_{ADVANCE}$  is used when the hazard could also be hit by vehicles travelling in the opposite direction. The equations to calculate the length of barrier needed for opposing traffic, on a straight or nearly straight section of road, and the barrier offset, are the same as used as for  $L_{ADVANCE}$  in Section 7.3.6 (e) (ii).

Figure 7.9 shows the design and layout details required to calculate the length of barrier needed in advance of a hazard, for opposing traffic on a straight, or nearly straight, section of road. The lateral dimensions are measured from the nearest edge of the closest traffic lane used by opposing traffic, ie. the centreline for opposing traffic on a two-lane two-way road and the right hand edge line of the median traffic lane on a dual carriageway road. A terminal conforming to at least NCHRP 350 TL - 3 must be provided in advance of the standard barrier section.

Where a hazard, is located beyond the clear zone width engineering judgement should be used when locating barriers in the following situations:

1. When the hazard is well beyond the clear zone, eg. a river, the designer may choose to shield only that portion lying within the clear zone by making  $L_A$  equal to  $L_C$ .

2. If the barrier is located beyond the clear zone no additional length of barrier is normally required but a terminal conforming to at least NCHRP 350 TL - 3 should be installed, based on a consideration of AADT, distance outside the clear zone and roadway geometry.
3. If the barrier is located within the clear zone an additional length of barrier will usually be required and a terminal conforming to at least NCHRP 350 TL - 3 must be installed.

Because the distance to a hazard is usually larger for opposing traffic, and encroachment angles often greater than those normally expected for adjacent traffic, some roading authorities use the following guidelines to determine the minimum length of barrier to be erected in advance of a hazard:

- the larger of the calculated length, or 30 m, where the design, or 85<sup>th</sup> percentile operating, speed is  $\geq 80$  km/h, and
- the larger of the calculated length, or 15 m, where the design, or 85<sup>th</sup> percentile operating, speed is  $\leq 70$  km/h.

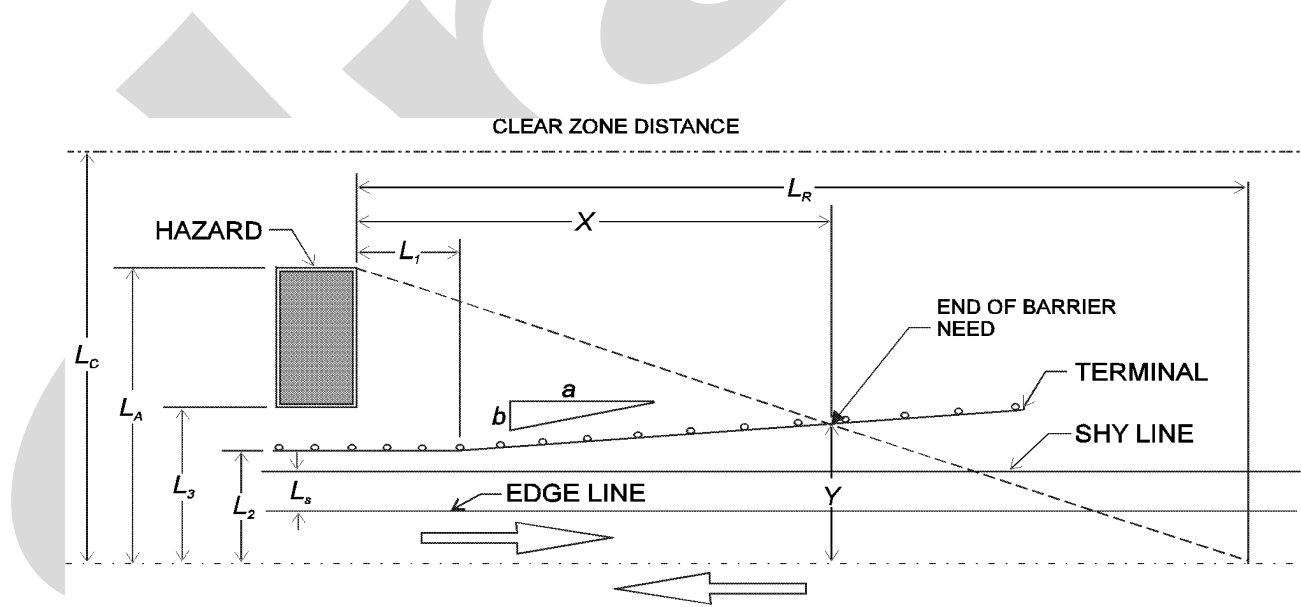

Figure 7.9: Length of Barrier Needed in Advance of a Hazard for Opposing Traffic

(e) **Graphical Method for Determining the Length of Need**

The length of need can be found by scaling details directly from road layout plans in the following manner:

- (i) Find the clear zone required for a straight level section of road from Table 6.10 or Figure 6.12.
- (ii) Make any adjustments necessary for gradient, horizontal curvature and roadside slope to get  $L_C$  and then compare this distance with the distance from the edge of the traffic lane to outside edge of the hazard,  $L_A$ . Generally, the smaller of these lateral distances should be used although wider areas may be shielded in some situations.
- (iii) Select the runout length,  $L_R$ , from Table 7.4.
- (iv) Plot the runout length and the lateral distance on the road layout plan. The runout length is scaled along the edge line of the appropriate traffic lane. The lateral distance is located on a line drawn along the near side of the hazard and perpendicular to the edge line of the appropriate traffic of traffic lane.

- (v) Draw a diagonal line between a point located on the lateral line at a distance of  $L_A$ , or  $L_C$ , and the end of the runout length furthest from the hazard. This line is the 'control line' and it represents the runout path of an errant vehicle. To shield the hazard the barrier must intersect this line. A terminal conforming to at least NCHRP 350 TL - 3 must be provided in advance of the standard barrier section.

The barrier may be either flared, using an appropriate flare rate, or parallel to the road, as dictated by site conditions.

**NOTE:** *Metal beam guardrail is manufactured in nominal 3.8 m lengths so the length of rail scaled should be rounded up to the nearest multiple of this length.*

(f) **Length of Barrier Needed to Shield a Hazard on a Horizontal Curve**

An errant vehicle leaving the road on the outside of a horizontal curve will generally follow a straight line tangential to the curve. The graphical method illustrated in Figure 7.10 below must be used to determine the length of need for a barrier located on the outside of a horizontal curve. The shorter of the tangential runout path or the runout length,  $L_R$ , is used.

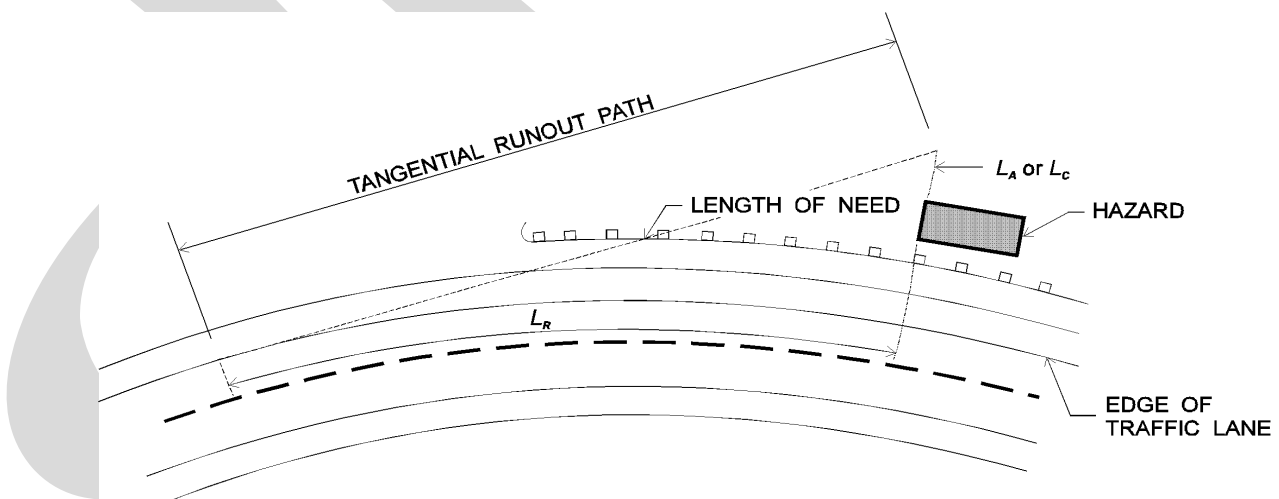

Figure 7.10: Length of Need for a Barrier Located on the Outside of a Horizontal Curve

**(g) Length of Barrier Needed to Shield a Hazard on a Dual Carriageway Road**

The length of roadside safety barrier needed to shield a hazard on a one-way carriageway section of a dual carriageway road is shown on Figure 7.11.

The start point and length of barrier needed in advance of the hazard is determined in the normal manner. The trailing end point of the barrier is determined by drawing a control line at 25° to the edge line of the traffic lane, as shown on the diagram below.

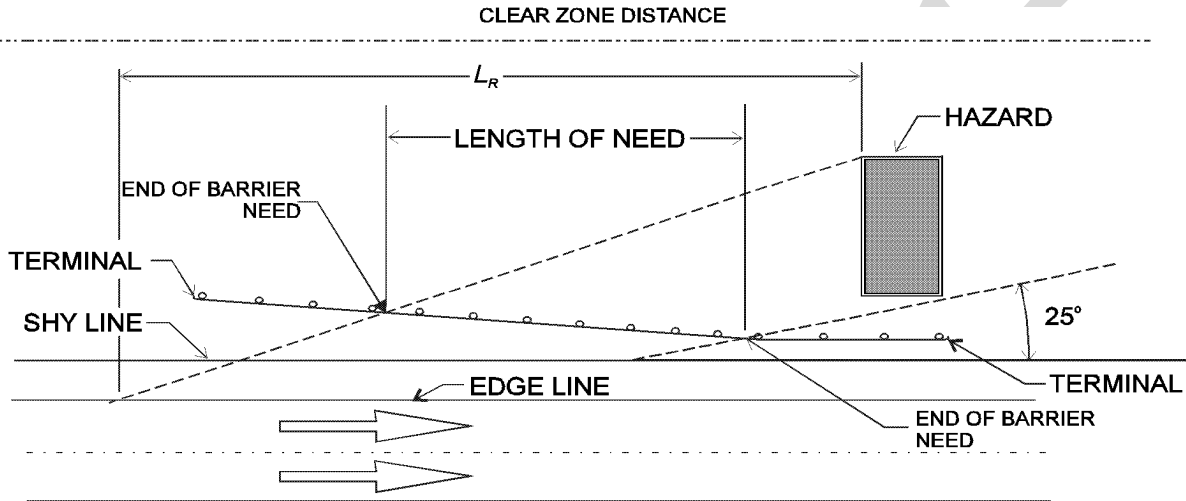

Figure 7.11: Length of Barrier Needed to Shield a Hazard on a One-way Section of a Dual Carriageway Road

**(h) Terminals (End Treatments)**

A terminal, or end treatment, conforming to at least NCHRP 350 TL - 3 must be added at each end of the total length of need,  $L_{TOTAL}$ .

Some terminals treatments resist lateral impacts and can be used as part of the length of need. Other terminals cannot and must be added to the length of need, this will result in a longer total barrier length.

**(i) Recovery Area**

If an errant vehicle penetrates a roadside safety barrier terminal the driver should be able to retain control of it. Therefore, a minimum recovery area should be provided behind all longitudinal road safety barrier installations, as illustrated in Figure 7.12.

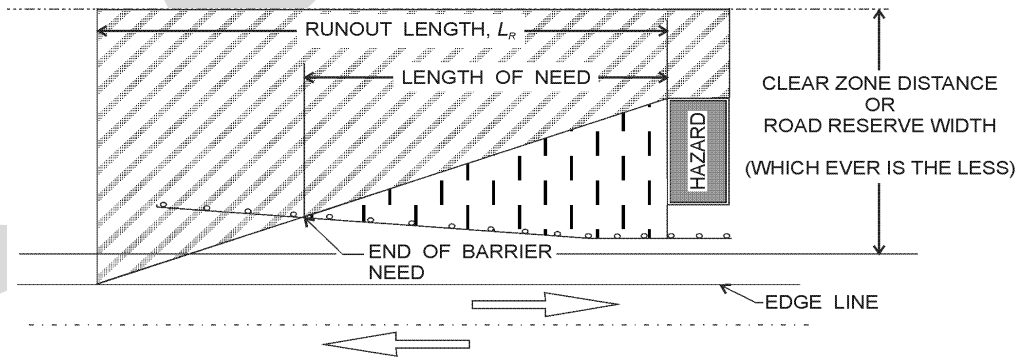

Fixed object hazards in this area must be checked to ensure that the length of barrier needed in advance of them is adequate



The area which must be free of obstructions and traversable by vehicles. This includes a path through and behind the terminal.

Figure 7.12: Clear Recovery Area Required Behind a Barrier Terminal

### 7.3.12 Median Barriers

#### (a) General

A median safety barrier should only be installed if the consequences of hitting the barrier are less severe than those that would result if no barrier existed. The warrant for the provision of median barriers on dual carriageway road state highways with traversable medians, ie. median side slope are  $\leq 1:6$ , is given in Figure 6.17. This warrant has been produced from research studies and analysis of the limited data available on cross-median accidents and, in the absence of site specific or more recent data, an explicit level of accuracy should not be implied.

**NOTE:** *The preferred side slope for a traversable median is  $\leq 1:20$ . The normal maximum side slope is 1:10, particularly when median barriers are installed. Side slopes of up to 1:6 may only be used in special circumstances - refer to Sections 6.6.1 and 7.3.9 (c) for more details.*

The minimum performance level for a state highway median barrier is NCHRP 350 TL - 3. This type of barrier will contain and redirect passenger vehicles but where there is a high percentage of heavy vehicles, adverse geometrics (horizontal curvature and gradient), or severe consequences of vehicular (or cargo) penetration into the opposing traffic lanes, higher performance barriers having significantly greater capabilities are used.

The performance level required for median barriers on state highways shall be determined by the method described in Section 7.3.12 (b) which is based on the AASHTO *Standard Specifications for Highway Bridges* method of determining safety barrier performance levels.

#### (b) Median Barrier Performance Requirements

The parameters used to determine median barrier performance level are:

- the design speed for new roads and the and the 85<sup>th</sup> percentile operating speed on existing roads,
- the percentage of heavy vehicles in the AADT,
- the offset to the face of the barrier from the edge of adjacent traffic lane, and
- a modified estimated AADT for the road 5 years hence.

(i) The modified AADT,  $AADT_{5M+}$ , is calculated by the following formula:

$$AADT_{5M+} = 0.7 \times K_g \times K_C \times AADT_{5+}$$

Where:

$K_g$  = Road gradient adjustment factor, from Figure 7.13

$K_C$  = Curve radius adjustment factor from, Figure 7.14.

$$AADT_{5+} = \begin{matrix} 1. & \text{The current AADT projected 5 years hence for existing roads.} \\ 2. & \text{The AADT expected 5 years after opening for new sections of road.} \end{matrix}$$

**NOTES:**

1. **The smallest radius / steepest grade combination on the section of road where the median barrier is to be installed must be used, and both directions of traffic considered.**
2. **AADT is:**
  - **the total two-way AADT for a centrally located double sided median barrier, or**
  - **the directional one-way AADT where a single sided median barrier is located adjacent to the median traffic lane, eg. on one, or both, carriageways of an independently aligned and graded dual carriageway road.**

(ii)  $AADT_{5M+}$  is compared with the adjusted AADT range in the relevant *Percentage of Trucks/Barrier Offset/Design Speed* cell of:

- Table 7.5 (a) for a double sided centrally located median barrier, and
- Table 7.5 (b) for a single sided barrier located adjacent to the median traffic lane.

(iii) If the  $AADT_{5M+}$  is greater than the higher value in the AADT Traffic range a NCHRP 350 TL - 4, type of barrier is warranted.

**NOTES:**

1. **An explicit level of accuracy should not be implied for Tables 7.5 (a) and (b).**
2. **Designer's should always apply engineering judgement to the selection of median barrier performance levels and specify higher than TL - 4 performance level barriers when they are considered necessary.**
3. **Refer to Section 7.3.8: Deflection for the minimum deflection requirements of flexible median barrier systems, particularly when there is more than 5% trucks in the AADT.**
4. **Refer to Section 7.3.12 (c) for recommended median barrier placement details.**

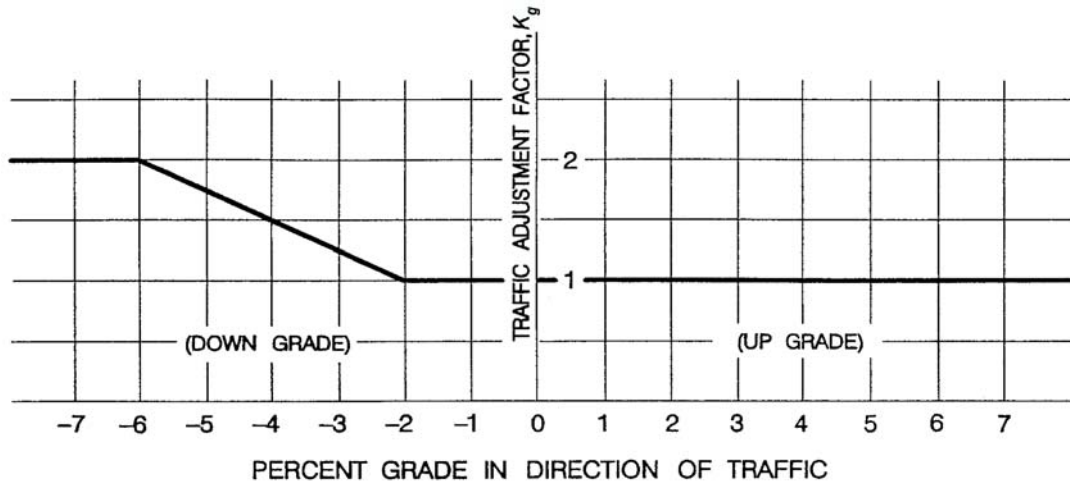

Figure 7.13: Road Grade Adjustment Factor,  $K_g$

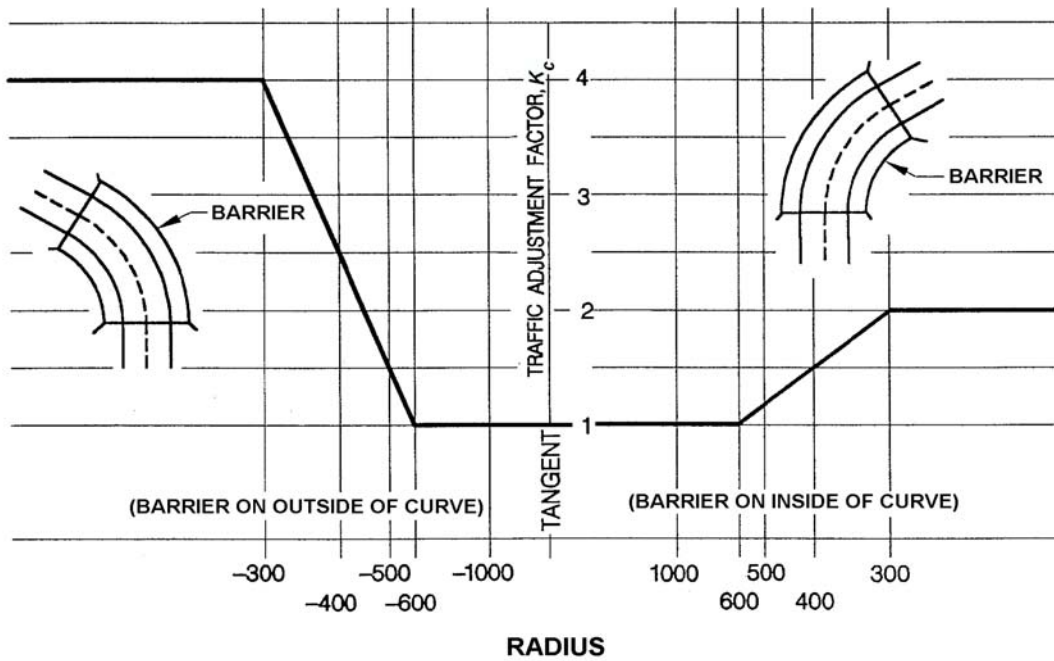

Figure 7.14: Horizontal Curvature Adjustment Factor,  $K_c$



Percentage Trucks in Total AADT	Barrier Offset from edge of Traffic Lane (m)	Adjusted AADT Ranges (vpd)		
		Design Speed (km/h)		
		80	100	110
		TL - 3	TL - 3	TL - 3
5	0 - 1	5,500 to 162,200	3,000 to 107,300	2,100 to 63,100
	1 - 2.1	6,300 to 188,600	3,300 to 126,300	2,300 to 80,000
	2.1 - 3.6	8,400 to 247,300	4,100 to 158,400	2,700 to 96,400
	> 3.6	11,200 to 314,700	5,000 to 203,800	3,100 to 127,600
10	0 - 1	4,700 to 50,000	2,800 to 39,600	2,000 to 32,100
	1 - 2.1	5,400 to 61,400	3,100 to 47,500	2,300 to 38,500
	2.1 - 3.6	7,200 to 70,600	3,900 to 53,100	2,600 to 42,200
	> 3.6	9,600 to 88,500	4,700 to 67,600	3,000 to 53,000
15	0 - 1	4,100 to 29,600	2,700 to 24,300	2,000 to 21,500
	1 - 2.1	4,800 to 36,700	2,900 to 29,300	2,200 to 25,300
	2.1 - 3.6	6,300 to 41,200	3,700 to 31,900	2,600 to 27,000
	> 3.6	8,400 to 51,500	4,500 to 40,500	3,000 to 33,500
20	0 - 1	3,700 to 21,000	2,500 to 17,500	1,900 to 16,200
	1 - 2.1	4,300 to 26,100	2,800 to 21,100	2,100 to 18,900
	2.1 - 3.6	5,600 to 29,100	3,500 to 22,800	2,500 to 19,900
	> 3.6	7,500 to 36,300	4,200 to 28,900	2,900 to 24,400

**Table 7.5 (a): Performance Level Selection Table for a Centrally Located  
Double Sided Median Barrier**

Percentage Trucks in Total AADT	Barrier Offset from edge of Traffic Lane (m)	Adjusted AADT Ranges (vpd)		
		Design Speed (km/h)		
		80	100	110
		TL - 3	TL - 3	TL - 3
5	0 - 1	2,800 to 81,100	1,500 to 53,700	1,100 to 31,600
	1 - 2.1	3,200 to 94,300	1,700 to 63,200	1,200 to 40,000
	2.1 - 3.6	4,200 to 123,700	2,100 to 79,200	1,400 to 48,200
	> 3.6	5,600 to 157,400	2,500 to 101,900	1,600 to 63,800
10	0 - 1	2,400 to 25,000	1,400 to 19,800	1,000 to 16,100
	1 - 2.1	2,700 to 30,700	1,600 to 23,800	1,200 to 19,300
	2.1 - 3.6	3,600 to 35,300	2,000 to 26,600	1,300 to 21,100
	> 3.6	4,800 to 44,300	2,400 to 33,800	1,500 to 26,500
15	0 - 1	2,100 to 14,800	1,400 to 12,200	1,000 to 10,800
	1 - 2.1	2,400 to 18,400	1,500 to 14,700	1,100 to 12,700
	2.1 - 3.6	3,200 to 20,600	1,900 to 16,000	1,300 to 13,500
	> 3.6	4,200 to 25,800	2,300 to 20,300	1,500 to 16,800
20	0 - 1	1,900 to 10,500	1,300 to 8,800	1,000 to 8,100
	1 - 2.1	2,200 to 13,100	1,400 to 10,600	1,100 to 9,500
	2.1 - 3.6	2,800 to 14,600	1,800 to 11,400	1,300 to 10,000
	> 3.6	3,800 to 18,200	2,100 to 14,500	1,500 to 12,200

**Table 7.5 (b): Performance Level Selection Table for a Single Sided Barrier  
Located Adjacent to the Median Traffic Lane**

**(c) Example Median Barrier Performance Level Calculation****Given:**

Median width	=	2.6 m - a 600 mm wide centrally located double sided concrete median barrier and 1.0 m median shoulders.
Design speed	=	100 km/h
AADT (two-way)	=	28,500 vpd
Traffic Growth rate	=	2.0%
$AADT_{5+}$	=	$(28,500 \times (1 + (0.02 \times 5)))$ = 31,350
% Trucks in AADT	=	10
Minimum radius	=	450 m (left hand curve)
Grade	=	- 3% (in the direction of travel on the left hand curve)
Barrier offset	=	1.0 m (median shoulder)

**(i) Up Grade Direction**

In this travel direction the curve is to the right and the barrier is on the inside of the curve.

$K_G$ , from Figure 7.13, is 1.0.

$K_C$ , from Figure 7.14, is 1.25.

$$\begin{aligned} AADT_{5M+} &= 0.7 \times K_G \times K_C \times AADT_{5+} \\ &= 0.7 \times 1.0 \times 1.25 \times 31,350 \\ &= 27,400 \end{aligned}$$

For 10% trucks in the AADT and a 100 km/h design speed the Adjusted AADT range, from Table 7.5 (a), is 3,100 to 47,500.  $AADT_{5M+}$  is within this range so a TL - 3 barrier is required.

**(ii) Down Grade Direction**

In this travel direction the curve is to the left, ie. the barrier is on the outside of the curve

$K_G$ , from Figure 7.13, is 1.25.

$K_C$ , from Figure 7.14, is 2.0.

$$\begin{aligned} AADT_{5M+} &= 0.7 \times K_G \times K_C \times AADT_{5+} \\ &= 0.7 \times 1.25 \times 2.0 \times 31,350 \\ &= 54,900 \end{aligned}$$

For 10% trucks in the AADT and a 100 km/h design speed the Adjusted AADT range, from Table 7.5 (a), is 3,100 to 47,500.  $AADT_{5M+}$  is outside this range so a TL - 4 barrier is required.

**A TL - 4 performance level median barrier is, therefore, required on this section of road - to meet the needs of the critical traffic direction, ie. down grade traffic on the 450 m radius curve.**

**(d) Median Barrier Placement**

The most desirable median is one that has relatively flat slopes, ie. preferably  $\leq 1:20$  and normally not more than 1:10, and is and free of rigid objects. In these conditions the barrier can be placed at the centre of the median. When these conditions cannot be met the following placement guidelines should be followed:

**(i) General**

Figure 7.15 illustrates the three basic types of median cross section. **Section 1** applies to depressed medians or medians with a ditch section, **Section 2** to stepped medians or medians that separate carriageways with significant differences in elevation, and **Section 3** to raised medians, or median berms.

**(ii) Section 1**

The side slopes and the ditch section should first be checked by the criteria in Section 7.2: *Ditches and Back Slopes* to determine if a roadside barrier is warranted. If:

- Both slopes require shielding a roadside barrier should be placed near the shoulder on each side of the median, ie. at points b and d on Figure 7.15: 1(a).
- Only one slope requires shielding, eg. S3 on Figure 7.15: 1(a), a rigid or semi-rigid median barrier should be placed at point d. A rub rail should also be installed on the ditch side of the barrier to prevent vehicles that have crossed the ditch from snagging on a post and beam barrier system.
- Neither slope requires shielding but both are steeper than 1:10, eg. Figure 7.15: 1(b), a median barrier should be placed on the side with the steeper slope. For example, if:

$$S2 = 1:6 \text{ and } S3 = 1:10,$$

the barrier would be placed at point b. A rigid or semi-rigid system is recommended in this situation.

- Both slopes relatively flat, refer to Figure 7.15: 1(c), a median barrier may be placed at, or near, the centre of the median, ie. at point c, if vehicle override is not likely. Any type of median barrier can be used, provided its dynamic deflection is not greater than one-half the median width.

**(iii) Section 2:**

If the embankment slope is steeper than approximately 1:10, refer to Figure 7.15: 2(a), a median barrier should be placed at point b. If the slope is not traversable, eg. rough rock cut., etc, a roadside barrier should be placed at both points b and d, as shown on Figure 7.15: 2(b). It is not unusual for this section to have a retaining wall at point d. If so, it is suggested that the base of the wall be contoured to the exterior shape of a concrete median barrier. If the cross slope is flatter than approximately 1:10, a barrier could be placed at, or near, the centre of the median, as shown on Figure 7.15: 2(c).

(iv) Section 1

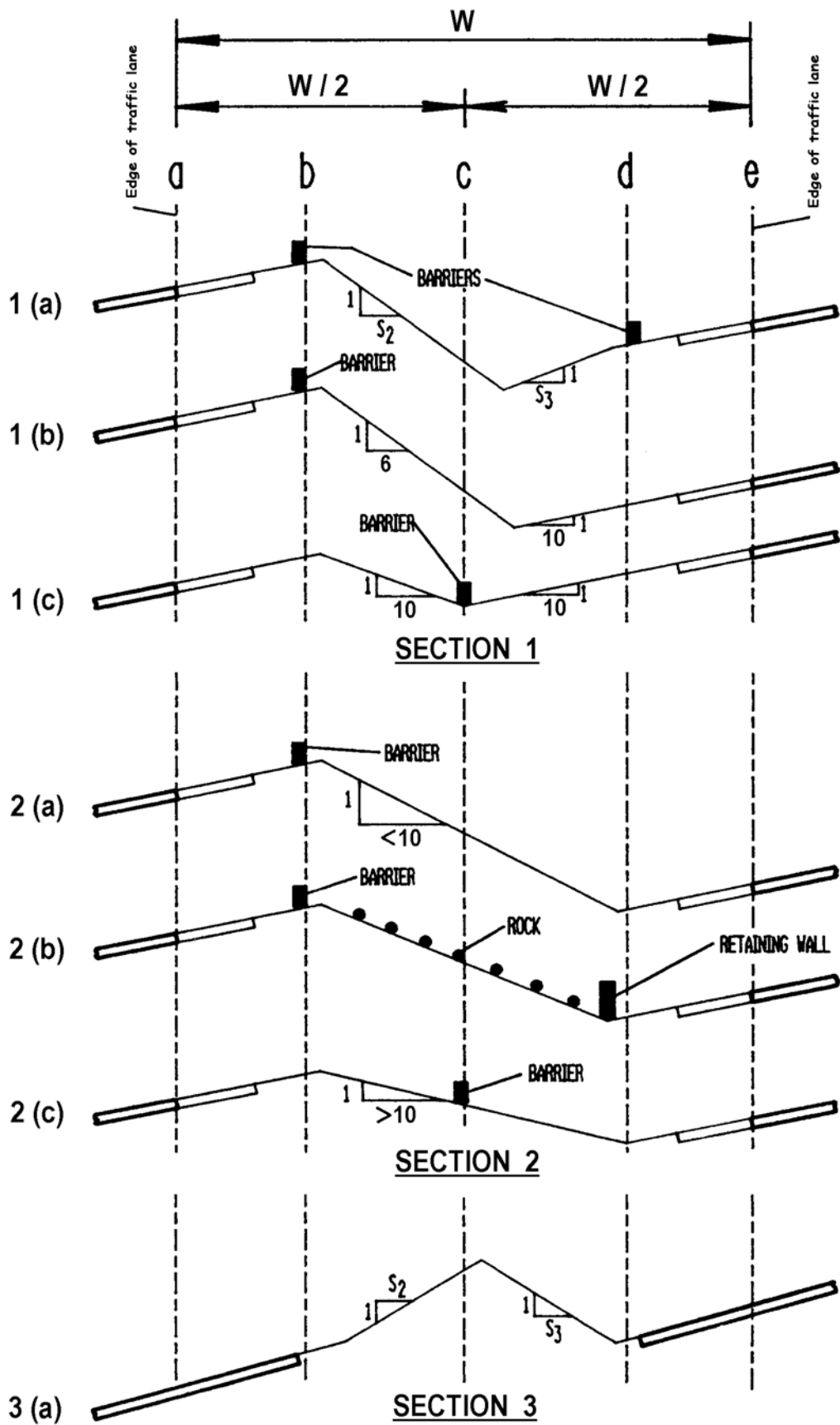

Figure 7.15: Median Barrier Placement

Placement criteria for median barriers on the type of cross section illustrated on Figure 7.15: 3(a) are not clearly defined.

Research has shown that if the median is high enough and wide enough, it can redirect errant vehicles that traverse it at relatively shallow angles. However, the following general rules should be applied:

1. If the side slopes are relatively flat and considered to be inadequate for redirecting errant vehicles, a semi-rigid median barrier should be placed at the apex of the cross section.
2. If the side slopes are not traversable, eg. rough rock cust, etc., a roadside barrier should be placed at points b and d.
3. If retaining walls are used at points b and d, the base of the wall be contoured to the exterior shape of a standard concrete barrier.

#### (e) Barrier Type

It is desirable that the same type of barrier be used throughout the full length of a section of road, and that the barrier be placed in the middle of a flat median.

However, it will be necessary to deviate from this policy in some cases. For example, the median cross section shown in Figure 7.15: 1(a) may require a barrier on both sides of the median. If a median barrier is warranted upstream and downstream of this section, the median barrier should be 'split' as illustrated in Figure 7.16. Most operational median barriers can be split this way, especially box beams, W-beam types and shaped concrete barriers.

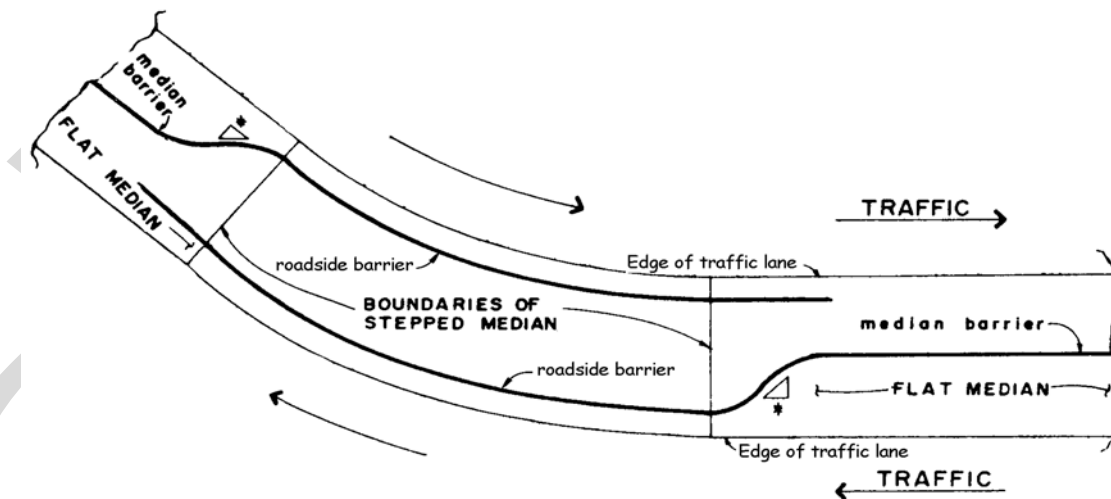

\* Flare rate should not exceed suggested limits (Refer to Table 7.3)

Figure 7.16: Split Median Barrier Layout

**7.3.13 Example Longitudinal Roadside Safety Barrier Calculations**

**(a) Bridge Pier Protection**

*Problem:*

Determine the roadside safety barrier requirements to shield the bridge piers shown in Figure 7.17 below.

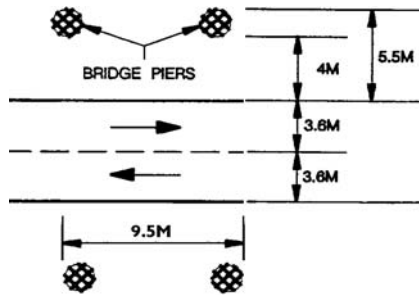

**Figure 7.17: Bridge Piers on a Two-lane Two-way Road**

*Given:*

- Barrier type = W-beam
- Design speed = 100 km/h
- AADT = 2850 vpd
- Embankment slope = Flat

**(i) Adjacent Traffic**

The barrier layout for the opposing traffic direction is shown in Figure 7.18. The clear zone distance,  $L_C$ , from Table 6.10 is 8.0 to 9.0 m. Therefore, the bridge piers need to be shielded.

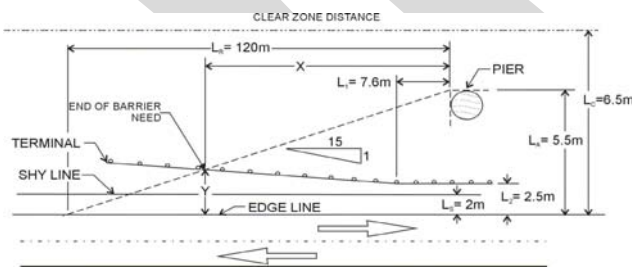

**Figure 7.18:  $L_{ADVANCE}$  Barrier Layout**

The runout length,  $L_R$ , from Table 7.4 is 120 m.

The shy line offset,  $L_S$ , from Table 7.1 is 2 m.

The deflection distance for a W-beam, from Table 7.2, is 1 m. The back of the barrier posts must, therefore, have at least 1 m clearance to the bridge piers. The width of the barrier is approximately 0.5 m which makes distance  $L_2 = 2.5$  m from the edge of the traffic lane, i.e. the W-beam is outside the shy line. The recommended flare rate in this situation, from Table 7.3, is 1:15.

Two straight, 3.81 m long sections of W-beam are needed before the flare is started, i.e.  $L_1 = 7.6$  m.

The length of barrier needed in advance of the bridge piers for adjacent traffic is:

$$X = \frac{L_A + ((b/a) \times L_1) - L_2}{(b/a) + (L_A / L_R)}$$

$$= \frac{5.5 + ((1/15) \times 7.6) - 2.5}{(1/15) + (5.5/120)}$$

$$= 31.2 \text{ m}$$

The flare offset  $Y = L_A - \left[ \left( \frac{L_A}{L_R} \right) \times X \right]$

$$= 14 - \left[ \left( \frac{14}{145} \right) \times 70.5 \right]$$

$$= 4.1 \text{ m, measured from the edge of the traffic lane.}$$

**(i) Opposing Traffic**

The barrier layout for the opposing traffic direction is shown in Figure 7.19. The runout length is the same as for the advance direction but the lateral offsets are measured from the centreline of the road, i.e. the edge of the opposing traffic lane.

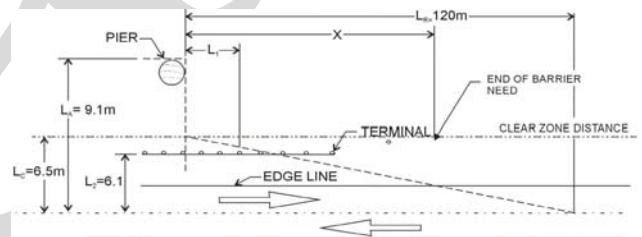

**Figure 7.19:  $L_{OPPOSING}$  Barrier Layout**

The distance to the back of the pier is 9.1 m, which is greater than the 8.0 to 9.0 m clear zone distance. The barrier is located within the clear zone so some additional length of barrier will be required to protect the piers, and a terminal conforming to at least NCHRP 350 TL - 3 should be installed.

The minimum length of additional barrier required in advance of the bridge piers for opposing traffic is:

$$X = \frac{L_A - L_2}{(L_A / L_R)} = \frac{6.5 - 6.1}{(6.5 / 120)}$$

$$= 7.4 \text{ m}$$

This is less than the 30 m length of barrier suggested in Section 7.3.6 (e) (iii) as a minimum for these situations. Engineering judgement must, therefore, be used in all cases to determine the length of additional of barrier to be installed.

In this case the minimum length of standard barrier considered necessary to shield the bridge piers,  $L_{TOTAL}$ , is:

$$34.3 + 9.5 + 7.4 = 48.1 \text{ m}$$

**(Round to 49.5 m and use 13 standard W-beam sections.)**

**(b) A Hazard Located on a Horizontal Curve****Problem:**

Determine the roadside safety barrier requirements on the outside of a horizontal curve to shield the hazard shown on Figure 7.20.

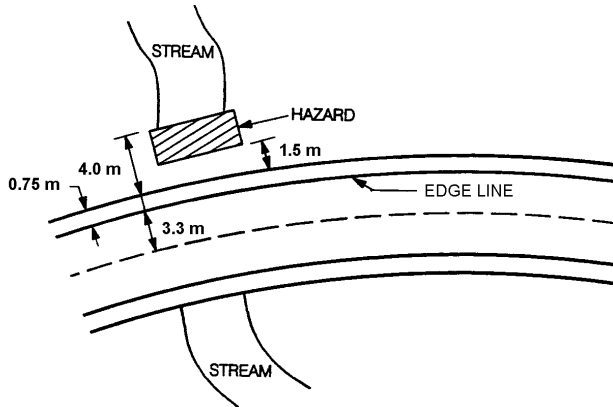

Figure 7.20: Hazard on a Horizontal Curve

**Given:**

Design Speed	=	90 km/h
AADT	=	500 vpd
Embankment slope	=	1:4
Curve radius	=	500 m
Type of barrier	=	W-beam

The mathematical method for determining the length of barrier needed is only applicable on straight, or nearly straight, sections of road. A graphical method must be used for horizontal curves.

The shy line offset for 90 km/h from Table 7.1 is 2.5 m. This is the desirable offset to a barrier in this situation but in this case the road cannot be widened sufficiently. The minimum barrier offset in any situation is 1.0 m and the shoulder in the hazard area must be widened to this standard and the surface sealed. Refer to Section 6.3 for details of shoulder width and seal requirements.

The horizontal curvature/gradient encroachment adjustment factor,  $M$ , from Figure 6.13 is 2. Figure 6.14 (a) gives a traffic volume adjustment factor,  $K$ , of 4. The effective traffic volume,  $EVT$ , is given by:

$$\begin{aligned} EVT &= K \times AADT \\ &= 4 \times 500 \\ &= 2000 \text{ vpd} \end{aligned}$$

From Table 6.10 the clear zone distance required on a straight level section of road with a 90 km/h design speed, an AADT of 2000 and side slopes of 1:5 to 1:4 is 7.5 to 9.0 m. The hazard is located 4.75 m from the edge line of the adjacent traffic lane - this is within the clear zone so it needs to be shielded. In this case the section of stream within the clear zone is not considered a hazard and does not need to be shielded.

A hazard offset line is drawn perpendicular to the road and along the approach side of the hazard, to intersect the centreline at point  $E_A$ . The hazard offset point is marked on this line at a distance of  $L_A$  from  $E_A$ .

Vehicles leaving the road on the outside of a horizontal curve generally follow a straight line tangential to the curve so the vehicle runout path can be constructed by drawing a line through the hazard offset point tangential to the edge line of the traffic lane, as shown on Figure 7.21. The runout path length is scaled as about 69 m, which is less than the 95 m runout length from Table 7.4.

The barrier is to be placed at the outer edge of the shoulder, which is to be widened to 1.0 m. The barrier line intersects the tangential runout path line about 36 m from the hazard offset line. This is the length of standard barrier needed, which could be further reduced by providing a flare up to 15:1 if space was available.

The length of barrier needed is adjusted to suit the standard number of standard W-beam sections, ie. 38 m, and a terminal conforming to at least NCHRP 350 TL - 3 added to the approach end of the barrier.

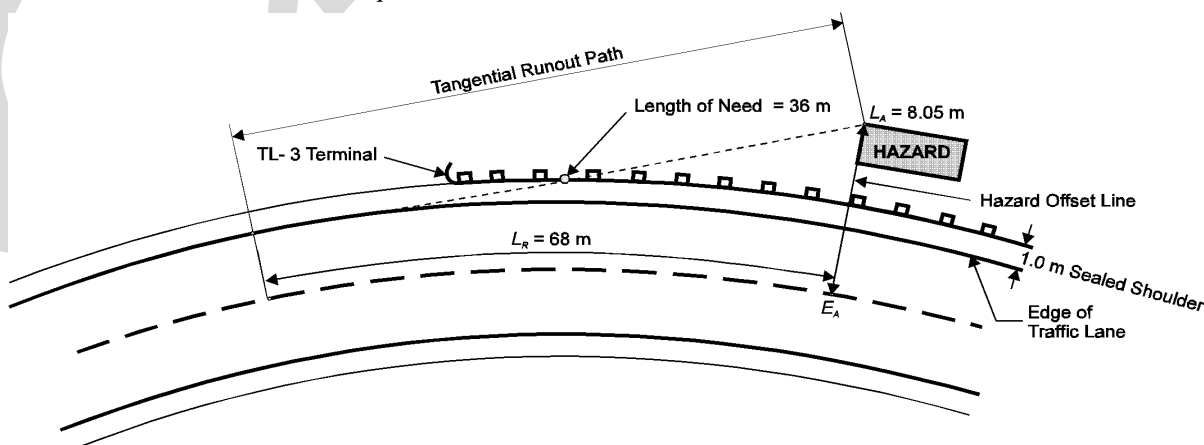

Figure 7.21: Length of Roadside Safety Barrier Required to Shield a Hazard on a Horizontal Curve

**(c) A Hazard Extending Beyond the Clear Zone**

**Problem:**

Determine the length of barrier needed on the left hand side for the one-way carriageway bridge approach shown in Figure 7.22.

**Given:**

- Bridge over river
- Design speed = 110 km/h
- AADT = 9000 vpd
- Fill slope = 1:4

**Graphical Solution:**

Table 6.10 indicates that a clear zone of 11.5 to 14.0 m is desirable in this situation. A clear zone distance,  $L_C$ , of 14.0 m will be used.

The runout length,  $L_R$ , of 145 m is obtained from Table 7.4 and is scaled onto Figure 7.22. The runout length is measured along the edge of the traffic lane and the far point labelled  $E_R$ .

The hazard must be defined before the distance to be shielded,  $L_A$ , can be determined. In this case the hazard is the river and an errant vehicle must be protected from it. The lateral distance to be shielded, therefore, is equal to the clear zone,  $L_C$ .

From the point of intersection of the clear zone with the river bank draw a line perpendicular to the edge of the traffic lane. This point is labelled  $E_A$  on Figure 7.22. From point  $E_A$  scale  $L_A = L_C = 14$  m.

Draw a diagonal line, called the control line, from the intersection of the clear line with the river to the point  $E_R$ . Then draw a line from the centre of the bridge rail to where it crosses the diagonal line between the point of clear zone and the point  $E_R$ .

Determine the shy line distance from Table 7.1. In this case the bridge rail is 3 m from the edge of traffic lane and this is the same as the shy line distance of 3.0 m. A straight or flared barrier may be installed.

If the barrier is placed along the straight line from the centre of the bridge then the scaled length of need is 108.3 m, 3 m of which is the bridge rail, see Figure 7.22.

If a flared installation is installed then the maximum flare rate from Table 7.3 is 15:1. Scaling a 15:1 flare rate after the 10.6 m section straight results in a barrier length of need of 68.5 m.

A proper transition must be used from a semi-rigid longitudinal barrier to a more rigid bridge rail. In addition a terminal conforming to at least NCHRP 350 TL - 3 must be added to the approach end of the barrier.

**Mathematical solution:**

- Clear zone  $L_C = L_A = 14$  m
- Runout length  $L_R = 145$  m
- Tangent section  $L_1 = 10.6$  m (7.6 m plus 3 m of bridge rail from line  $L_A = L_C$ )
- Barrier offset  $L_2 = 3.2$  m
- Flare rate = 15:1

**Straight installation:**

$$X = \frac{L_A - L_2}{(L_A / L_R)} = \frac{14 - 3.2}{(14 / 145)} = 111.9 \text{ m, 3 m of which is bridge rail.}$$

**Flared installation:**

$$X = \frac{L_A + ((b / a) \times L_1) - L_2}{(b / a) + (L_A / L_R)}$$

$$= \frac{14 + ((1 / 15) \times 10.6) - 3.2}{(1 / 15) + (14 / 145)}$$

$$= 70.5 \text{ m, 3 m of which is bridge rail.}$$

$$Y = L_A - \left[ \left( \frac{L_A}{L_R} \right) \times X \right]$$

$$= 14 - \left[ \left( \frac{14}{145} \right) \times 70.5 \right]$$

$$= 7.2 \text{ m, measured from the edge of the traffic lane.}$$

**NOTES:**

1. The calculated values resulted in slightly larger values for the length of need than that obtained by scaling.
2. For an existing bridge the barrier would probably be installed parallel to the shoulder because a flared installation would require extensive earth works, making it a more expensive option.

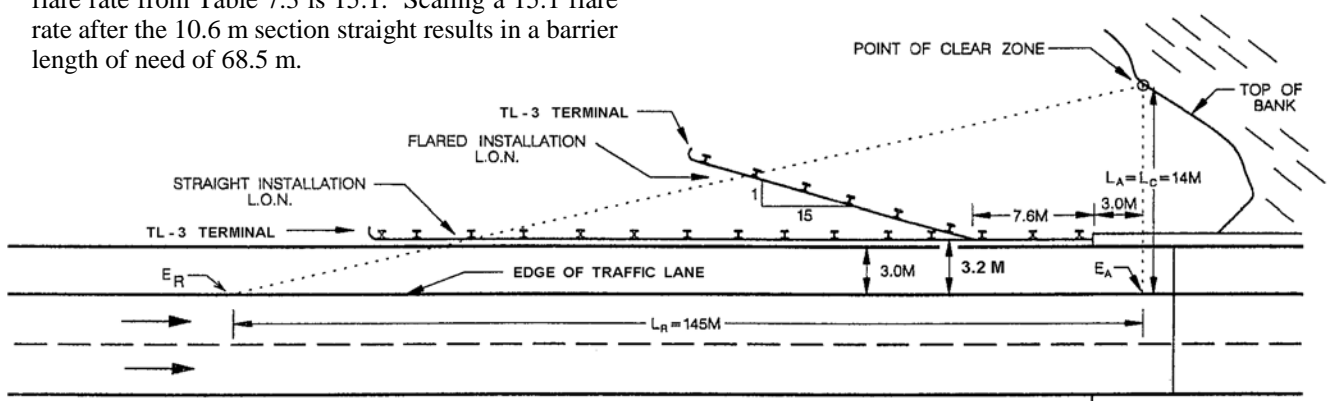

**Figure 7.21: Length of Roadside Safety Barrier Required to Shield a Hazard Extending Beyond the Clear Zone**

## 7.4 Breakaway Designs

### 7.4.1 Introduction

The Road Safety Manufacture's Association (RSMA) Standard for the Manufacture and intenance of Traffic Signs, Posts and Fittings prescribe the technical requirements specified for Erection and Maintenance of Traffic Signs, Chevrons, Markers and Sight Rails on State Highway.

The need for traffic signs, roadway illumination, utility service and postal delivery results in roadside features frequently placed within the roadway right-of-way. The presence and location of these obstacles varies by roadway type and location. Rural freeways, for example, can be designed where traffic signs are the only obstacles that are added to the roadside. Signs, light pole standards, utility poles and mail boxes are all frequently encountered on rural collectors. These obstacles, when present, perform a necessary function, but are also potential fixed objects for an errant vehicle. To reduce accident severity it is important that signs, roadway illumination supports, utility poles and mailboxes be designed to breakaway when hit by an errant vehicle.

Yielding or breakaway supports are recommended on all types of sign, luminaire, and mailbox supports that are located within the desirable clear zone.

Yielding supports refer to those supports that are designed to remain in one piece and bend at the base upon vehicle impact. The anchor portion remains in the ground and the upper assembly passes under the vehicle. The term "breakaway support" refers to support systems that are designed to break into two parts upon vehicle impact. The release mechanism for a breakaway support can be a slip place, plastic hinges, fracture elements or a combination of these.

Figure 7.22 (a) & (b), illustrate slip-base breakaway mechanisms.

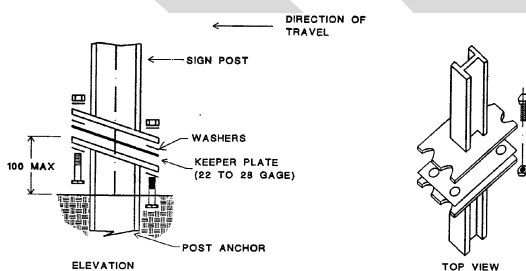

Figure 7.17 (a): Unidirectional Slip-base

NCHRP 350 establishes current testing guidelines for vehicular tests to evaluate the impact performance of permanent and temporary highway features and supersedes those contained in NCHRP 230. These guidelines include a range of test vehicles, impact speeds, impact angles, points of impact on the vehicle, and surrounding terrain features for use in evaluating impact performance. Acceptance testing of yielding and breakaway supports require evaluation in terms of the degree of hazard to which occupants of the impacting vehicle are exposed, the structural adequacy, the hazard to works and pedestrians that may be in the path of debris from the impact, and the behaviour of the vehicle after impact.

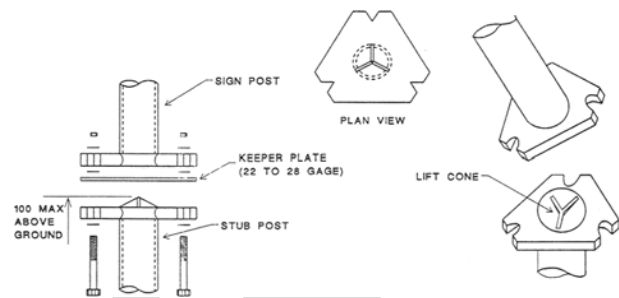

Figure 7.17 (b): Multidirectional Slip-base

The guidelines include requirements for:

- The structural adequacy of the device to determine if detached elements, fragments or other debris from the assembly penetrate, or show potential for penetrating, the passenger compartment or present undue hazard to other traffic.
- A range of preferable and maximum vehicle changes in velocity resulting from impact with the support system. The preferable change in vehicle velocity is 3.0 m/s or less. The maximum acceptable change in vehicle velocity is 5.0 m/s.
- The impacting vehicle remain upright during and after the collision.
- The vehicle trajectory and final stopping position after impact should intrude a minimum distance, if at all, into adjacent or opposing lanes.

Impacts with breakaway supports can be hazardous even at lower speeds, especially for occupants of a small vehicle. It should be noted that many supports can be more hazardous at low speeds (25 to 40 km/h) than at high speeds (90 to 100 km/h). For example, sign supports that fracture or breakaway can be more hazardous at low speeds where the energy imparted to the support is not sufficiently large to make the device swing up and over the vehicle. The result can be intrusion of the lower portion of the support into the passenger compartment. Similarly, devices designed to yield are generally more hazardous at high speed, due to the reduced time available for deformation and subsequent passage beneath the vehicle.

The acceptance testing guidelines are intended to enhance experimental precision while maintaining cost within acceptable bounds. The wide range of vehicle speeds, impact angles, vehicle types, vehicle condition and dynamic behaviour with which vehicles can impact the support can not be economically replicated in a limited number of standardised tests. The use of an approved device does not, therefore, guarantee that it will function as planned under all impact conditions. However, the failure or adverse performance of a highway safety feature can often be attributed to improper design or construction details. The incorrect orientation of a unidirectional breakaway support, or something as simple as a substandard washer, are major contributors to improper function. It is important, for proper device function, that the safety feature has been properly selected, assembled and erected and that the critical materials have the specified design properties.



A characteristic of slip-base support is that, when impacted at normal urban operating speeds, they are generally dislodged from their original position and often do not significantly retard the progress of the impacting vehicle. This raises the issue of secondary crash potential where this type of support is used in areas of high pedestrian activity, parking and abutting development density and in narrow medians. It is strongly recommended that slip-base supports be not used in high pedestrian activity areas. When possible, and appropriate, the placement of traffic signs, luminaries, utility and mailbox supports should take advantage of existing barrier, overhead structures and other features, which will reduce their exposure to traffic. Care should be taken to ensure that supports placed behind existing, warranted barriers, are outside the maximum design deflection standards of the barrier. This will prevent damage to the support structure and help ensure that the barrier functions properly if impacted. The design deflections are based on crash tests using a 2000 kg vehicle impacting the barrier at 100 km/h and an angle of 25 degrees. The crash tests are conducted under optimum conditions. Other conditions such as wet, frozen, rocky or sandy soil may result in deflections greater or less than the design values. Typical anticipated deflections are summarized on table 7.2.

#### **7.4.2 Traffic Signs**

Signs contribute an important role in increasing the safety of the roadway by providing regulatory, warning, control and guidance information to the driver. Every sign that is installed on its own support system, however, provides a fixed object for a potential collision. Even a relatively small sign on an apparent weak support can have severe consequences when struck at high speed.

The first steps in the design of any sign is to determine if a sign is really needed and where it should be placed. The Manual of Traffic Signs and Markings (MOTSAM) provides information on when traffic signs should be installed and also provides guidelines on the height and lateral placement of typical sign installations. In rural areas, signs should be no closer than 600 mm to the edge of the shoulder and between 2 m and 5 m from traffic lane. In urban areas signs should be located between 300 mm and 500 mm from the kerb face.

##### **(a) Sign Components**

The three components of a sign assembly are the sign panel, the support, and the embedment or anchorage system. Each component contributes to the effectiveness, structural adequacy, and safety upon impact of the device. The sign assembly must be structurally adequate to withstand its own weight and the wind and ice loads subjected to the sign panel.

Opposing the need for structural adequacy is the requirement that the sign assembly provide a safe driving environment. The installation must be performed with proper design and construction to achieve the required performance.

##### **(b) Sign Support Considerations**

There are a variety of systems used to support ground mounted traffic signs. They can be categorised by designating them as single or multiple mount systems. Multiple mount systems have two or more supports spaced at

least 2100 mm apart. Signs mounted on a single support and those with multiple supports less than 2100 mm apart are considered as single mount systems. The 2100 mm separation criteria allows for the possibility that an errant vehicle leaving the roadway could impact more than one support.

Multiple support systems, in addition to the supports being separated by more than 2100 mm, must also be designed for each support to independently release from the sign panel. Therefore, sign panels must have sufficient torsional strength to ensure proper release from the impacted support while remaining upright on the support(s) which were not impacted. This also requires that the remaining support(s) have sufficient strength properties to prevent the sign panel from breaking loose and entering the passenger compartment or becoming a projectile.

Metal supports that yield upon impact have been used for many years to provide effective, economical supports for traffic signs. Yielding supports are designed to bend at the base and have no built-in breakaway or weakened design. Systems in this category include the full length steel U-channel, aluminium shapes, aluminium X-posts, tubes and standard steel pipes. For successful impact performance, the support must bend and lay down or fracture without causing a change in vehicle velocity of more than 5 m/s. Tests have shown that supports which fracture offer much less impact resistance, especially at high-speed impacts, than yielding supports of equal size.

The impact behaviour of base bending supports depends upon a number of complex variables including cross-sectional shape, mechanical properties, chemical properties, energy absorption capabilities under dynamic loading, the type of embedment, and the characteristics of the embedment soil. The wide number of variables related to the properties of the support itself require that full scale crash testing be performed to evaluate the impact behaviour of base bending supports. The performance requirements of support types need to be specified during their purchase to help ensure proper action during impact. For example, U-channel posts, while of the same shape, will have different impact characteristics depending upon their unit weight and whether they are cold rolled or hot shaped.

The impact performance of base bending supports depends upon the interaction between the structure and the soil in which it is embedded. Soil conditions vary drastically with location, even within small geographic locations. Due to this variability NCHRP 350 has established standard soil (previously referred to as "strong soil") and weak soil conditions for testing. Weak soil consists of relatively fine aggregates, which provide less resistance to lateral movement than that provided by a standard soil.

The rules on weak soil/standard soil are, however, in question. Recently completed crash testing yielded very few acceptable supports in weak soil. A device that has only been found acceptable in strong soil may only be used in strong soil.

The proper performance of some base bending supports require that they do not pull out of the soil upon low speed impact. Placing these base-bending devices at an improper embedment depth, or in weak soil when they have only been approved for use in standard soil will not provide acceptable low speed performance. If the device was installed on a narrow median, for example it can pull out of the ground upon impact and become a lethal trajectory to opposing traffic. Consideration must be given to the soil acceptance criteria of the post planned for use, the soil condition present, sign location, and the safety performance needs of the sign assembly.

Breakaway supports are designed to separate from the anchor base upon impact. Breakaway designs include supports with frangible couplings, supports with weakened sections, bolted sections and slip base designs. Breakaway supports are classified by their ability to properly separate from the base upon impact from one direction (unidirectional) or from any direction (multidirectional). Large signs, requiring multiple supports separated by 2100 mm or more, should use a hinged breakaway mechanism with a horizontal slip base. Various types of hinges and the action of the hinged breakaway are illustrated in Figure 7.23 (a) & (b).

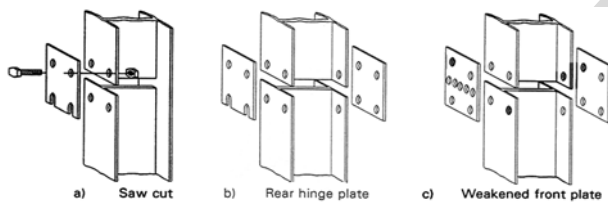

Figure 7.23 (a): Common Hinge Design

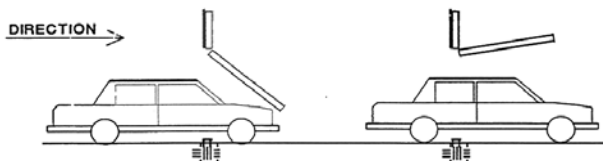

Figure 7.23 (b): Illustration of hinged breakaway action

In addition to the yielding and breakaway sign supports, are overhead and fixed base support systems. Overhead sign support systems include the use of existing structures, such as bridges, that span the traffic lanes. Fixed base support systems include those that do not yield or breakaway upon impact. Fixed base systems are often used for traffic sign supports to support overhead signs on roadway facilities with three or more lanes. The large mass of these support systems and the potential safety consequences of the system falling to the ground necessitate a fixed base design. Fixed base systems are rigid obstacles and should not be used in the clear zone area unless shielded by a barrier.

### 7.4.3 Light Support Systems

#### (a) General

The primary purpose of roadway illumination is to increase safety by enhancing night time visibility.

The net safety benefit from increased visibility is influenced by the hazard posed by the roadway lighting or luminaire support acting as a fixed object. If roadway illumination is not warranted, or if it is installed incorrectly, there is a strong possibility that traffic hazards will be increased rather than reduced by providing roadway illumination. Illumination supports are categorised as shown in Figure 7.19.

#### (b) Rigid Support

Rigid supports are designed to withstand vehicular impacts without undue deformation whilst remaining in an upright position. This type of support should not be used within clear zone without shield.

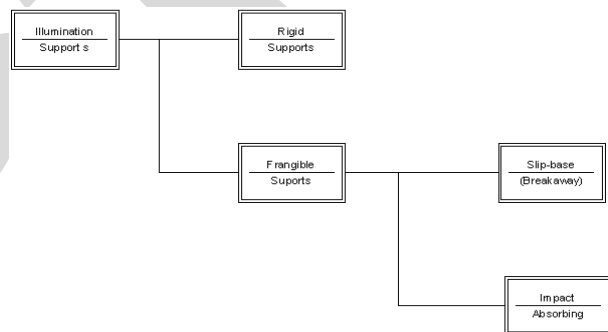

Figure 7.24: Illumination Support Categories

#### (c) Slip-base Poles

Slip-base poles are a very effective form of frangible support. This uses a slip base that provides a shear plane to initiate pole rotation away from an impacting vehicle. The result is a breakaway pole that reduces the probability of severe injury to vehicle occupants.

The mass of luminaire structures requires careful consideration to placement concerns. The presence of kerbs, fill slopes or other features which result in impacts above the design impact point will result in unsatisfactory slip-base pole performance upon impact. The trajectory of the pole after impact generally is in line with the path of the vehicle with the mast arm usually rotating 180 degrees from its mounted position. The trajectory line and rotation generally prevent the pole from projecting into other traffic lanes and becoming an additional hazard. The placement of slip-base pole on narrow medians and on top of improperly designed concrete safety shapes, can result in impacted poles becoming a hazard for other traffic. When installed on top of median concrete safety shape barrier, the base should not be made breakaway so that the luminaire does not fall into the opposing lane when hit.

While the trajectory of the pole is in line with the vehicle path, it is not always in front and underneath the impacting vehicle. Depending on the speed of impact the luminaire structure can come down on top of the vehicle. To minimise the consequences of this secondary impact, assemblies should be as light as possible, while maintaining structural integrity and required stiffness for proper breakaway action.

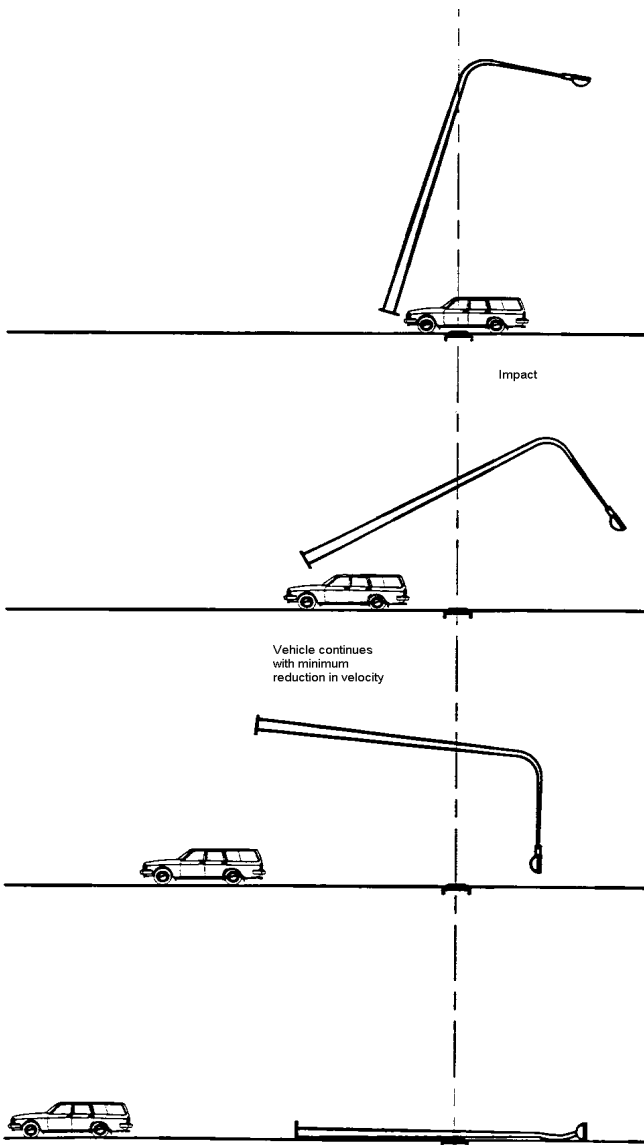
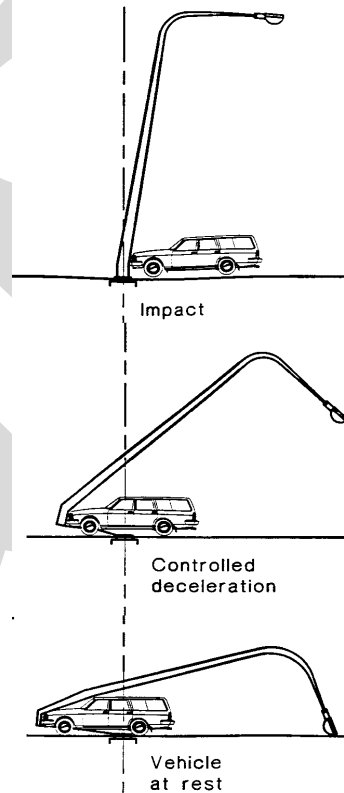

**Figure 7.25: Slip-base Pole**

**(d) Impact Absorbing Pole**

Impact absorbing poles are very similar in appearance to the rigid support. They differ from slip-base type pole in that, in a vehicle impact, they remain attached to the base structure and absorb any impact by progressively deforming and entrapping the impact vehicle.

A designed weakening of the pole stem over the lower length controls the deformation of the pole. The pole brings the impacting vehicle to a stop, generally within a distance of less than half the mounting height. This type of pole provides a satisfactory degree of crash worthiness, ie. particularly suited to low vehicle speed and high pedestrian activity area where they may be concern of secondary accidents associated with dislocation of slip base pole.



**Figure 7.26 Impact Absorbing Pole**

**7.4.4 Influence of Terrain on Breakaway Support Performance**

Breakaway supports are designed and evaluated to operate safely based on the characteristics of the vehicle fleet. One of the primary characteristics included in discussions of the impacting vehicle is its weight. While weight is very important, the bumper height is equally important since it establishes where the vehicle weight is first concentrated on the breakaway support. The majority of the safety evaluation tests are conducted on level terrain. This implies that the impacting design vehicles are striking the breakaway supports at a known height; typically about 500 mm above the ground. Roadside safety could, therefore, be enhanced if wide level areas are provided along the roadside.

Providing this level roadside is no practical or possible in the majority of roadside situations. Side slopes, ditches, cross slopes, kerbs, and other drainage and terrain features are necessary roadside design features. How these features can interact with and influence vehicle trajectory and device performance must be considered prior to device installation.

Breakaway support devices are designed to function properly when the slip base is subjected to shear forces. If the point of impact is at a significantly higher point than the design height of 500 mm then sufficient shearing forces may not be transmitted to the base. The result can be binding of the mechanism and non-activation of the breakaway device. It is critical, therefore, that breakaway supports not be located near abrupt changes in elevation, super elevation transitions, changes in slope, or kerbs which will cause vehicles to become partially airborne at the time of impact. As a general rule, if side slopes are limited to 1:6 or flatter between the roadway and the breakaway support, vehicles will usually strike the support at an acceptable height.

Supports should not be placed in locations where the terrain features can possibly impede their proper operation. Placing supports in drainage ditches can result in erosion and freezing which can affect the operation of the breakaway support. In addition, vehicles entering the ditch can be inadvertently guided into the support. Supports should not be installed closer than 2100 mm to other fixed objects. If the supports are placed closer than 2100 mm to other objects; which by themselves are considered acceptable, eg. a tree trunk less than 100 mm in diameter, then a vehicle will be able to strike both the support and the object simultaneously. The combined effect of both the tree and the support on the change of velocity can be much higher when impacting both objects simultaneously.

Terrain in the vicinity of the support base must be graded to allow vehicles to pass over portions of the support that remain in the ground or that are rigidly attached to a foundation. Remaining portions of the support, which protrude more than 100mm above the ground line over a horizontal span of 1.5 m, as shown in Figure 7.27, can snag the vehicle undercarriage.

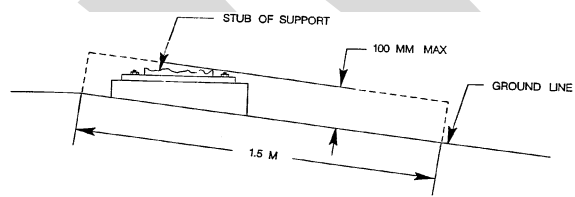

Figure 7.25: Breakaway Support Stub Height Measurement

## 7.5 Traversable and Non-traversable Drainage Features

### 7.5.1 Introduction

The introduction to clear zone design, presented as Section 6, indicated that the greatest safety is achieved on an obstacle free, almost level roadside. If this obstacle free area could be extended for large distances then the majority of vehicles that leave the roadway would be able to safely stop and return to the roadway. While this may be an ideal situation, it is not realistic. Constraints in available right-of-way, roadside terrain features, natural obstacles, and man made obstacles require compromises between absolute safety and engineering needs.

One engineering need, that itself has a direct impact on safety, is providing adequate drainage. Roadways are constructed as crowned or superelevated sections to remove water from the road surface. Adequate drainage facilities are required to channel this water away from the roadway to prevent damage to the roadbed and surface ponding. In addition to hydraulic concerns, drainage features must be designed with proper consideration to their consequences on roadside safety.

It is common for drainage features such as culvert ends and headwalls to interrupt otherwise traversable roadside clear zones and medians. If left untreated, vehicle impacts on these features may be extremely severe resulting in violent rollovers or abrupt stops. Using roadside barriers to shield these features may not be a desirable treatment due to the length of barrier required to shield even a single culvert end. The barrier reduces potential accident severity, but due to the length of the barrier, accident frequency is increased.

This section addresses the design concerns associated with kerbs, pipes and culverts, headwalls, and drop inlets. It provides recommendations on the location and design of these features that can increase their safety performance without decreasing their hydraulic performance. In general, the following alternatives, listed in order of preference, are applicable to all drainage features.

#### (a) Eliminate Drainage Structures

The preferred treatment for drainage features is to extend the culvert beyond the clear zone. The feasibility of removing the hazard is usually a function of the roadside geometry. If adequate right-of-way width is available, and it is possible to extend the roadside embankment, extending cross-drainage structures beyond the desirable clear zone may be possible. This treatment often offers the secondary advantage of further flattening the embankment slope, making the clear zone even more recoverable.

#### (b) Redesign or Modify Drainage Feature to make It Traversable

Treating the culvert ends to make them traversable can be accomplished by placing grates over the ends of the pipe. For the inlet end of pipes in flat medians, a drop-inlet with a suitable grate over the opening is traversable, and maintains favourable hydraulic characteristics. Pipe ends on embankments can be made traversable by the addition of widely spaced bars placed across the pipe and perpendicular to the direction of traffic flow, ie. parallel to the axis of the culvert. A similar treatment can be provided for culverts parallel to the main roadway, such as those passing under intersecting roadways, driveways, or median crossovers. However, the bars must still be oriented perpendicular to the main roadway, which in this case places them perpendicular to the axis of the culvert. Full-scale crash tests have demonstrated the ability of grates to permit vehicles to safely traverse the culvert end.

#### (c) Shield the Drainage Feature

If a necessary drainage feature cannot be designed safely or relocated, and it presents a hazard, then it should be shielded by a suitable barrier.

### 7.5.2 Drainage Concerns

The information presented in this section applies to all roadway types. However, the concerns expressed pertaining to the application of the clear zone concept still apply. These concerns are repeated below.

- The desirable clear zone distances obtained from Figure 6.12 are intended as general guidelines, not absolute values. The magnitude of the hazard, the potential for vehicle impact and the proximity of other fixed objects must be considered and, as with many other engineering applications, the selection of an appropriate countermeasure at a specific location depends on the exercise of good engineering judgement and assessment of the associated costs and benefits.
- As a general rule, at locations with a good probability of vehicle encroachment, fixed objects and non-traversable slopes located within the clear zone should be relocated, redesigned or shielded.
- Shielding by longitudinal barriers and crash cushions should only be implemented when the hazard posed by the barrier or cushion is less than that posed by the unshielded obstacle. Barriers and crash cushions are normally located closer to the carriageway, extend over a greater length or occupy more area and reduce the recovery area available than just the obstacle alone. Their use could, therefore, be expected to increase the number of accidents experienced at a specific location. The use of a properly designed barrier can, however, reduce the severity of such accidents.

### 7.5.3 Kerbs

Kerbs are used as a means of separating the roadway from the roadside and are also often installed to reduce maintenance operations, provide pavement edge support and to assist in drainage control. While kerbs are frequently used on all types of urban roads, caution should be exercised with their use on rural roads. Kerbs should not be used on rural, high speed roads when the same objective for their installation can be obtained by another method. If kerbs are used, they should be removed after they are no longer necessary.

Kerbs are classified into the general categories of **Barrier** kerbs and **Mountable** kerbs, each category having numerous types and design details. Both kerb designs are frequently provided with a gutter section to drain water from the carriageway within tolerable limits. Improperly designed drainage facilities can result in vehicles hydroplaning on roadway surface water.

Barrier kerbs are relatively high, usually 100 to 150 mm, and have steep faces which are intended to inhibit vehicles from leaving the carriageway. Mountable kerbs are designed so that vehicles can easily cross them. Mountable kerbs with face slopes of 1:2 or flatter should not be more than 150 mm high, to prevent snagging of a vehicle undercarriage. Mountable kerbs with face slopes of 1:1 should not be made more than 100 mm high.

When kerbs are necessary to control drainage or to protect erodible soils the designer should consider the following to enhance roadside safety:

#### (a) Design Speed

In general, neither barrier nor mountable kerbs should be used on roadways where design speeds exceed 65 km/h. When impacted at high speed, kerbs do not prevent vehicles from leaving the road and can cause them to roll over if the impact occurs while a vehicle is spinning or slipping sideways.

Under other impact conditions, vehicles can become airborne after striking a kerb. This not only results in loss of control, but can become critical if secondary impacts occur with traffic barriers or other roadside appurtenances.

#### (b) Roadside Barriers

Kerbs are not desirable in front of traffic barriers since they can result in unpredictable post impact trajectories, as shown in Figure 7.28. The best practice is to avoid using kerbs in the vicinity of guardrails.

If a kerb must be used its effect can be minimised by using a maximum kerb height of 100 mm and placing it so that the face of the kerb is no more than 200 mm in front of the barrier, and preferably at or behind the face of the barrier, and stiffening the beam to reduce deflection. This requires barrier posts to be located immediately behind the kerb when there should be a distance of at least 3.6 m from the kerb to the barrier. 3.6 m is the minimum distance needed to allow vehicles that have been vaulted by the kerb to return to ground level prior to impacting a barrier.

In urban areas, the barrier/kerb combination should be offset at least the shy line distance shown in Table 6.1 from the edge of the traffic lane. This offset may be continuous (kerb with or without barrier) or variable. A continuous offset should be used if there are numerous separate runs of barrier along a route to provide a uniform kerb offset. The use of thrie-beam instead of W-beam where kerbs and footpaths approach a bridge rail is recommended. Where barriers are to be installed in the vicinity of an existing kerb, the kerb should be removed unless the barrier can be placed as discussed above.

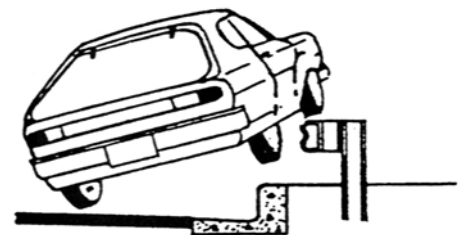

Figure 7.28: Vehicle Hitting a Kerb

### 7.5.4 On-road Drainage Inlets

On-road drainage inlets are usually located near or on the kerb or shoulder of a roadway. They are designed to remove the runoff from the road surface. On-roadway inlets include grated inlets, kerb opening inlets, slotted drain inlets or a combination of these basic designs. Proper design of on-road inlets requires:

- (a) That they pose no hazard to errant motorists.
- (b) Surface inlets must be capable of supporting vehicle wheel loads and present no obstacle to pedestrian and bicycle traffic. Spacings as small as 20 mm between parallel grate bars can trap bicycle tires. Transverse spacers or bars should be used for all roadway surface grates so that they are bicycle safe.

There are trade offs involved in the loss of hydraulic efficiency versus increase in safety. Hydraulic engineers should evaluate the hydraulic design needs considering the amount of flow, expected debris and grate inlet performance.

### 7.5.5 Off-road Drop Inlets

Off-road drop inlets are designed to collect runoff and are often located in the median of divided roads and in roadside ditches. Their hazard to errant vehicles can be minimised, and their hydraulic efficiency maximised, by constructing them flush with the ditch bottom or slope on which they are located. The opening should be treated to prevent a vehicle wheel from dropping into it, but, unless pedestrians are a concern, the openings do not need to be as small as required for on-road grates.



Figure 7.29 (a): Headwall and Wingwall Inlet

### 7.5.6 Cross Drainage Features

#### (a) General

Cross drainage structures are designed to carry water underneath and perpendicular to the road. They can vary in size from 300 mm concrete or corrugated metal pipes to large shapes 3 m or more in diameter. To reduce erosion problems the inlets and outlets for the larger sections usually have concrete headwalls and wingwalls and the smaller pipes bevelled end sections, as illustrated in Figures 7.29 (a) & (b).

Cross drainage structures can pose a hazard to errant vehicles due to the design of the headwall or wingwall and the drainage opening itself. Headwalls and wingwalls often result in concrete extending above the road surface level and errant vehicles can become snagged on the exposed concrete, or even drop into the drainage opening. These types of hazards can be minimised by:

- installing a traversable design,
- moving the drainage structure away from the travelled way, and/or
- shielding the structure.

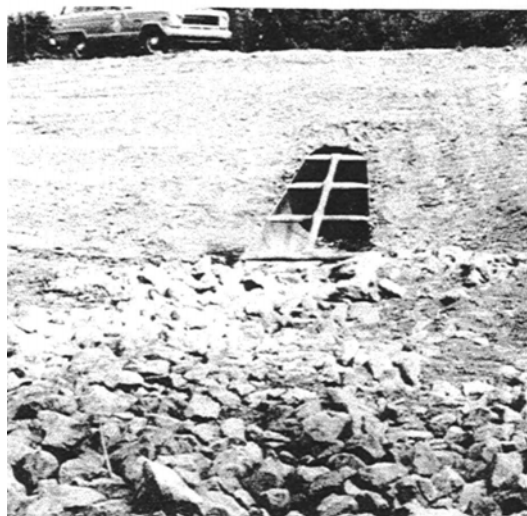

Figure 7.29 (b): Bevelled Inlet

**(b) Traversable Designs for Cross Drainage Structures**

The inlets and outlets of cross drainage structures can generally be located on the front slope or bottom of parallel ditches. If the front slope is 1:3 or flatter, it is preferable to extend, or shorten the cross drainage structure to match the face of the embankment slope. Matching the structure to the slope results in a traversable design, reduces hazard area, reduces erosion problems and simplifies mowing operations.

Matching the drainage structure to the slope of the embankment is all that is required when the slope is 1:3, or flatter, and the culvert has a single round pipe of 915 mm or less. Pipes with a clear opening width of 1000 mm and greater can be made traversable for passenger vehicles by using grates or pipes to reduce the clear opening width. Crash tests indicate that automobiles can cross culvert end sections on slopes as steep as 1:3 at speeds as low as 30 km/h and as high as 100 km/h when steel safety pipes are placed on 750 mm centres for cross drainage structures. This spacing does not provide a smooth ride over the culvert but will prevent wheel entrapment and not decrease the hydraulic capacity of the culvert. The flow capacity can be adversely affected, however, if debris accumulates and causes partial clogging of the inlet. It is important that proper maintenance be performed to keep the inlets free of debris.

The safety pipes for cross drainage structures should run from top to bottom of the drainage structure. This will orientate the safety pipes so that an errant vehicle, travelling parallel to the roadway, will have its wheel travel from pipe to pipe and not fall between adjacent safety pipes. Figure 7.30 shows design details for a cross drainage structure pipe grate.

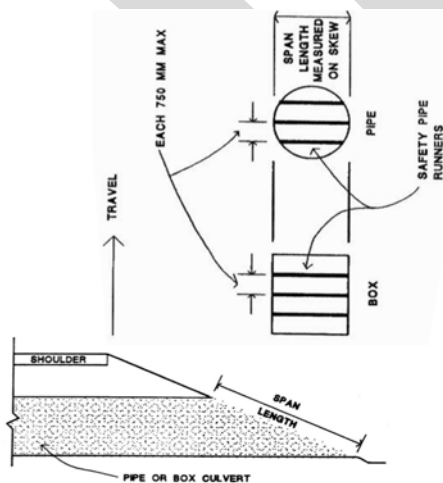

**Figure 7.30: Details of Safety pipes Installation for Cross Drainage Structures**

**(c) Structure Extension**

Extending a cross drainage structure whose inlets and outlets cannot be made traversable, beyond the clear zone, reduces the possibility of the pipe and being impacted; but it does not eliminate the possibility. The desirable clear zone is not an exact distance and engineering judgment is required. For example, if after extension the culvert headwall is the only significant obstacle at the edge of a traversable clear zone, then the extension may not be the best alternative. This is particularly true on high speed roadways, controlled access facilities and specific locations with a high probability run-off-the-road occurrence. Redesigning the inlet/outlet so that it is traversable and no longer an obstacle is the preferred treatment.

**(c) Shielding**

When either making the inlet/outlet of cross drainage structures traversable or extending beyond the clear zone are not possible or cost effective, then shielding is the last alternative. Shielding with an appropriate traffic barrier can often be the most effective method of decreasing accident severity.

Full embedment of the guardrail posts is often not possible when continuing a roadside guardrail across a low fill culvert. This difficulty has resulted in the use of shortened wood posts set in concrete and the use of steel posts bolted to the headwall. Both of these solutions increase installation costs, and often provide insufficient resistance upon impact and can be expensive to repair when impacted. Another frequently used solution is to construct a concrete safety shape across the culvert and attach the approach guardrail with an approved transition design. This solution also significantly increases installation costs.

Two alternative designs have been developed and approved for use by FHWA. These designs eliminate the posts that cannot be embedded to the standard depth. The systems were stiffened by nesting the rail element so the deflections were similar to those of a semi-rigid system. One design spans an opening of 3.8m using two 3810mm sections or three 3810mm sections of nested W-beam, depending on where the rail splices fall. The other design spans an opening of 5.7 m using 3 nested sections of 3810mm long W-beam. This designs are shown in Figure 7.26 (a) & (b).

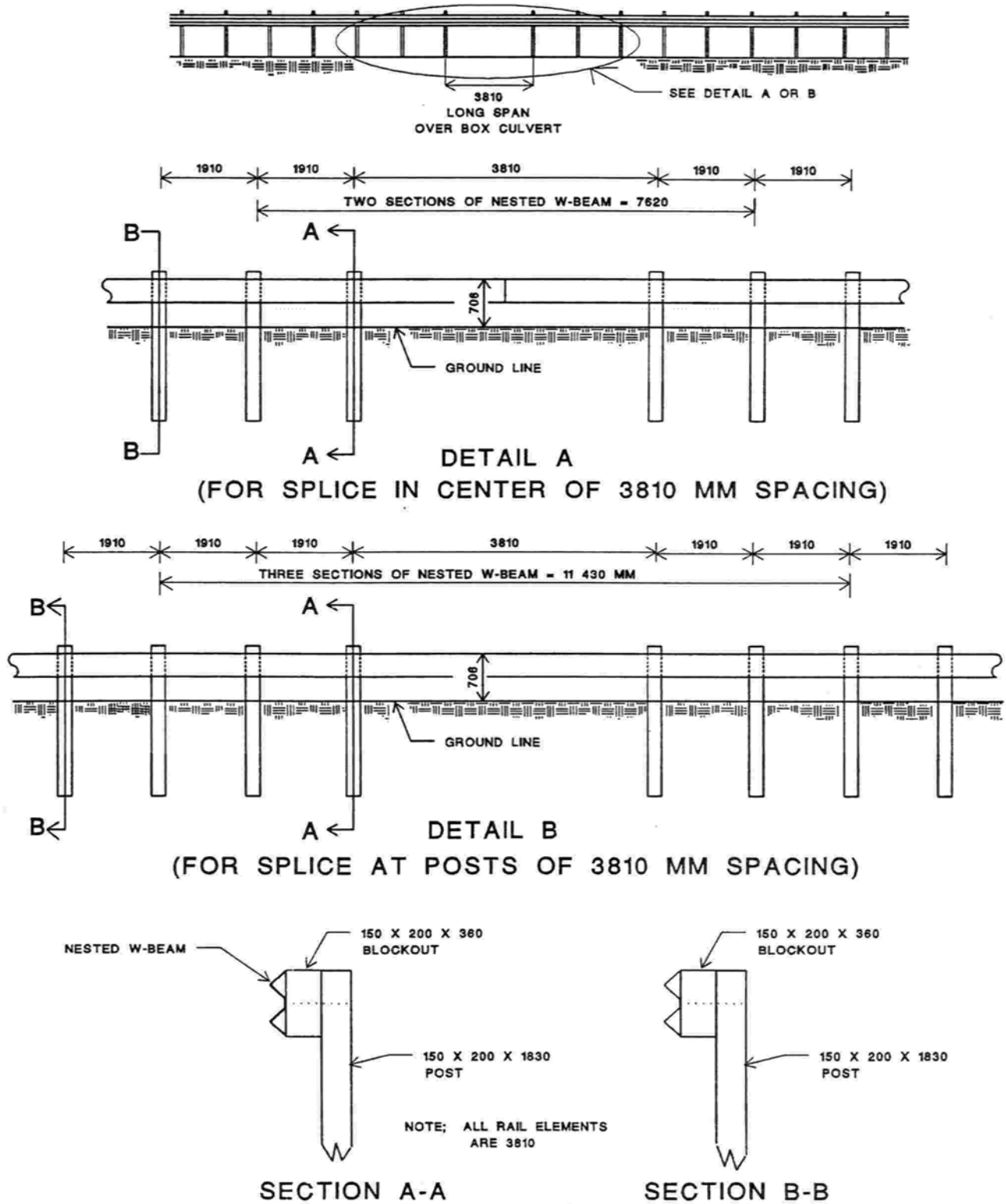

Figure 7.31 (a): Details of Nested W-beam Wood Post Guardrail over 3.8m Clear Span



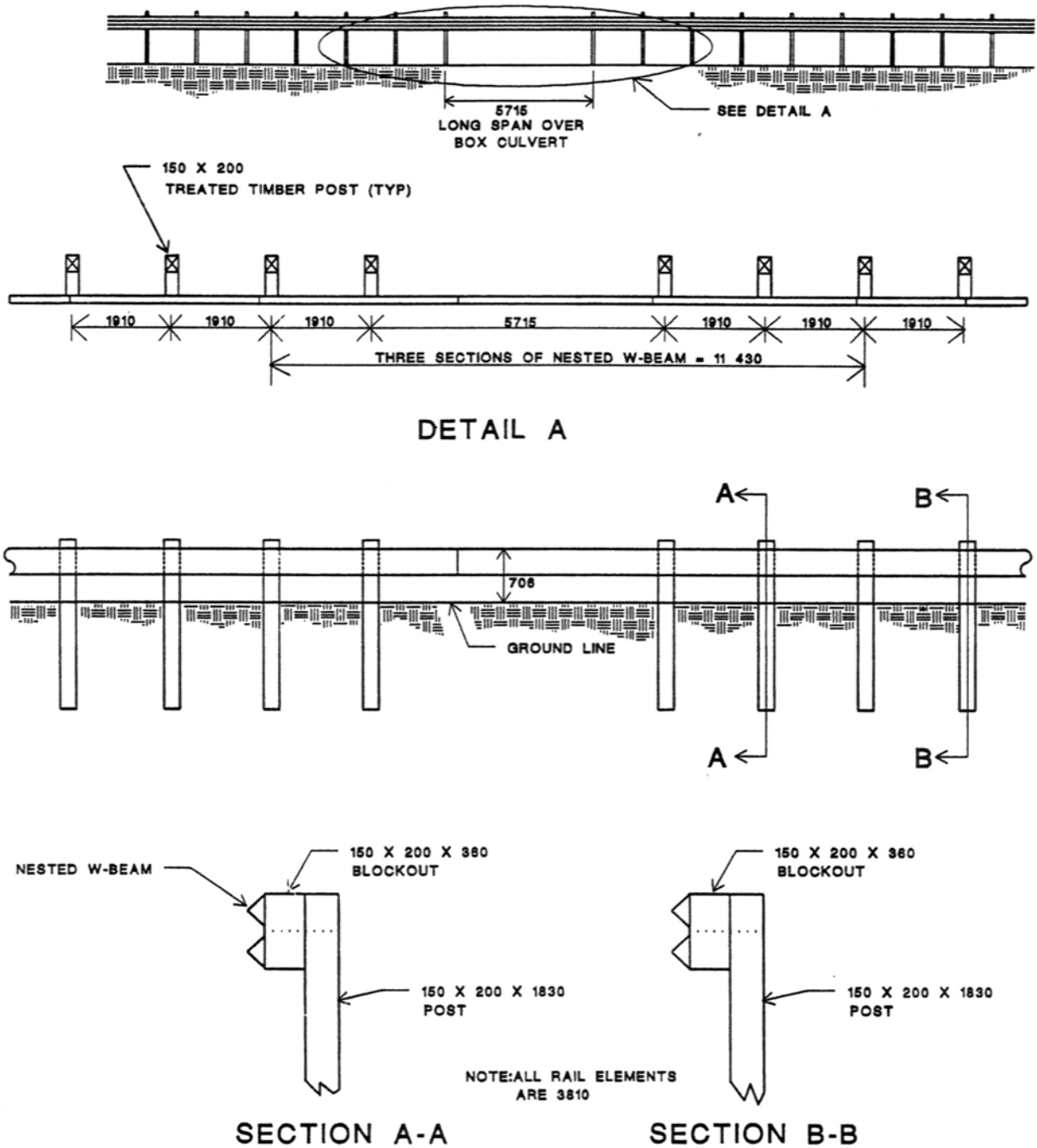

Figure 7.31 (b): Details of Nested W-beam Wood Post Guardrail over 5.7m Clear Span

### 7.5.7 Parallel Drainage Structures

Parallel drainage culverts continue the flow of parallel ditches under driveways, intersection roadways and median crossovers. Parallel drainage features present a significant safety hazard because they can be struck head on by impacting vehicles. Effective treatments for improving the safety of parallel drainage features, in order of preference, include:

- Eliminate the structure
- Relocate the structure
- Install a traversable design
- Shielding the structure

#### (a) Eliminate the Structure

Eliminating parallel drainage structures is the preferred choice for increasing roadside safety. This can be accomplished by developing an overflow section and by converting an open ditch to a storm drain.

An overflow section is an alternative that should be exercised with care. It consists of eliminating the parallel pipes by allowing the water from the parallel ditch to flow over the surface of intersecting minor roads, field entrances and driveways. This treatment is only appropriate at low volume locations and requires lowering the intersection roadway surface. One major problem with overflow designs is that they can reduce the sight distance available to drivers entering the major road at the same time that the resultant minor road upgrade causes increased vehicle passage time. Water freezing on the roadway surface and erosion are also potential problems. The erosion problem can be reduced by paving the overflow section, on gravel roads, and by adding upstream and downstream aprons at locations where water velocities and soil conditions make erosion likely.

Connecting an open ditch to a piped storm drain is the ideal, but expensive, solution. The expense of a piped storm drain can, however, be cost effective at appropriate locations. Rural roads with closely spaced residential driveways are good candidates for converting an open ditch to a storm drain. Similarly, the outsides of curves and sections of road where there is a history of run-off-the-road accidents are good locations to convert an open ditch into a storm drain and backfilling the areas between adjacent driveways. This treatment eliminates the embankments and ditch bottom as well as the pipe inlets and outlets.

#### (b) Relocate the Structure

Where there is sufficient road reserve area at intersections, a parallel drainage structure can be moved further from the edge of the main road. This also enables the provision of a flatter embankment slope within the desirable clear zone of the main road. Although the structure is further removed from the main road, it is still recommended that the inlet and outlet match the embankment slope.

#### (c) Install a Traversable Structure

It is recommended to provide the flattest feasible cross slopes, especially in locations with a high probability of head-on accidents with drainage structures. Cross slopes of 1:10 or flatter are suggested, with slopes of 1:20 desirable when possible. The pipe inlet and outlet structures should match the selected cross slope.

Research on parallel drainage structures has shown that grates consisting of pipes or bars set on 600 mm centres, and installed perpendicular to traffic, can reduce wheel snagging in the drainage opening. As a general rule for parallel structures, single drainage pipes of 600 mm, or less, diameter pipe do not require a grate. However, when multiple drainage pipes are involved, the installation of a grate for the smaller drainage pipes should be considered. The centre of the bottom safety pipe should be set at 100 mm to 200 mm above the culvert inlet. The 100 mm to 200 mm range applies to back inlet and outlet on two-way roadways and only to the side facing traffic on divided roadways. Figure 7.32 shows an example of an inlet /outlet grate for a parallel drainage structure.

Figure 7.33 illustrates a cross drainage safety slope end section for a cross drainage structure. These metal end sections attach to the existing pipe and extend the culvert to achieve a 1:6 slope.

#### (d) Shielding the Structure

Shielding the obstacle with a traffic barrier may be necessary when the parallel drainage structure cannot be made traversable, cannot be relocated or eliminated, or is too large to be treated effectively.

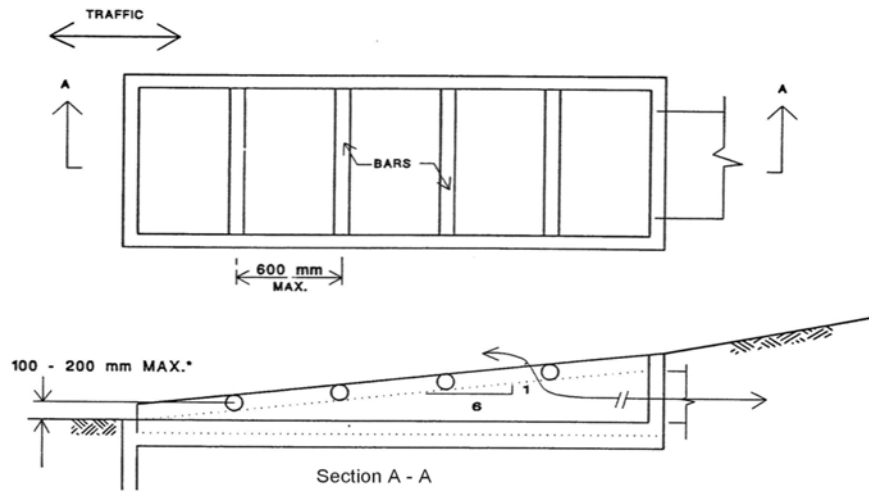

The 100 - 200 mm range applies to both inlet and outlet on two-way roads and only to the side facing traffic on divided highways.

**Figure 7.32: Example of Inlet / Outlet Design for Parallel Drainage Structures**

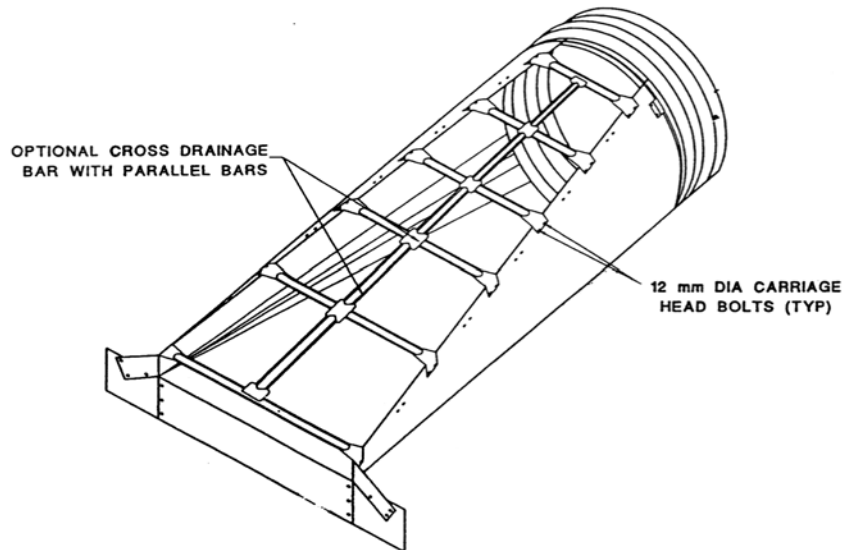

**Figure 7.33: Cross Drainage Safety Slope End Section**

(This page is intentionally blank)